

New Tools in Meridian and Regulus

Version 9

Content

1.	New Tool: AI Engine Assistant.....	3
2.	Tables of Planetary Revolutions of Mercury, Venus, Mars, Jupiter and Saturn (MAV9)4	
3.	Hermetic Astrology (MAV9).....	6
4.	Solar Return with Annual Solar Arc Progression and Lunar Return with Lunar Arc Progression (MAV9).....	9
5.	Atacirs in Solar and Lunar Returns (MAV9)	10
6.	Synodic Lunar Return (E. Linares)	11
7.	Astrocartography Display in Spherical Mode, Fixed Stars and Animation Panel (MAV9).....	12
8.	Transits, Progressions and Cartography Cycle with Animation (MAV9).....	14
9.	Austral Chart (MAV9)	15
10.	Simple Chart Design Tool with up to 6 Additional Dials (MAV9)	16
11.	Conjunction Impact Analysis Tool in Forecasting / Radix Techniques with Configurable Orb (MAV9).....	17
12.	Conjunction Impact Analysis Tool in Forecasting / Radix Techniques with Configurable Orb (MAV9).....	18
13.	Huber Age Progression Dates for Two 72-Year Cycles (MAV9)	19
14.	Proluna Dates by Boris Cristoff for Two 84-Year Cycles (MAV9).....	20
15.	New Points Added (MAV9).....	21
16.	Venus Star Pentagram Tool (MAV9).....	22
17.	Relationship Venus Star Pentagram Tool (MAV9)	23
18.	Mercury Star Report Tool (MAV9).....	24
19.	Mercurial Types Tool (MAV9).....	25
20.	Pregnancy Almuten (Omar Tiberiades) (MAV9).....	26
21.	Gestational Chart (Hermes/Bailey) (MAV9).....	27
22.	I Interaspects and Polarities (A. Polito)	28
23.	Heptagrams (D. Neroman) (MAV9).....	29
24.	Gestational Memories (I. Guimaraes) (MAV9)	30
25.	Dispositors Tool	31
26.	New Aspects Panel	32
27.	New Drawing Panel.....	33

28.	Animation Panel	34
29.	Astrological Assistant	35
30.	Primary Directions Arc Tables with Contact Reports.....	36
31.	Aspects to Cusps Tables	37
32.	Astrodynes Display according to Demetrio Santos	38
33.	New Interpretation Text for Harmonic Flower.....	39
34.	Multiple Composite Chart.....	40
35.	Gauquelin Sectors Tool.....	41
36.	Individual Planetary Cycles Tool	42
37.	Lunations and Eclipses Charts Tool (Melocation Module)	43
38.	Birthday Alert Tool.....	44
39.	Angel of the Day Tool.....	45
40.	Improvements in Fixed Stars Editor	46
41.	Improved Magnifier Quality	47
43.	Sign Comparison Tool with Transit Wheel	48
44.	AAF Data Import Option (Astro.com)	49
45.	Kabbalah Chart – Lej Lejá Method by Eugenia Pinery (Kabbalah Module).....	50
46.	REXAS and REX-Zero (D. Santos).....	51
47.	C800 Cycle Tool (D. Santos).....	52

**MAV9 – Indicates that the tool was included in the Version 9
Advance Module**

1. New Tool: AI Engine Assistant

Generates prompts for AI in Natal Charts, Forecasting (Returns, Progressions, Directions, Transits, Lunations, Eclipses, Atacires, etc.) and Synastry.

Allows the generation of prompts in plain text and JSON format for use with AI systems.

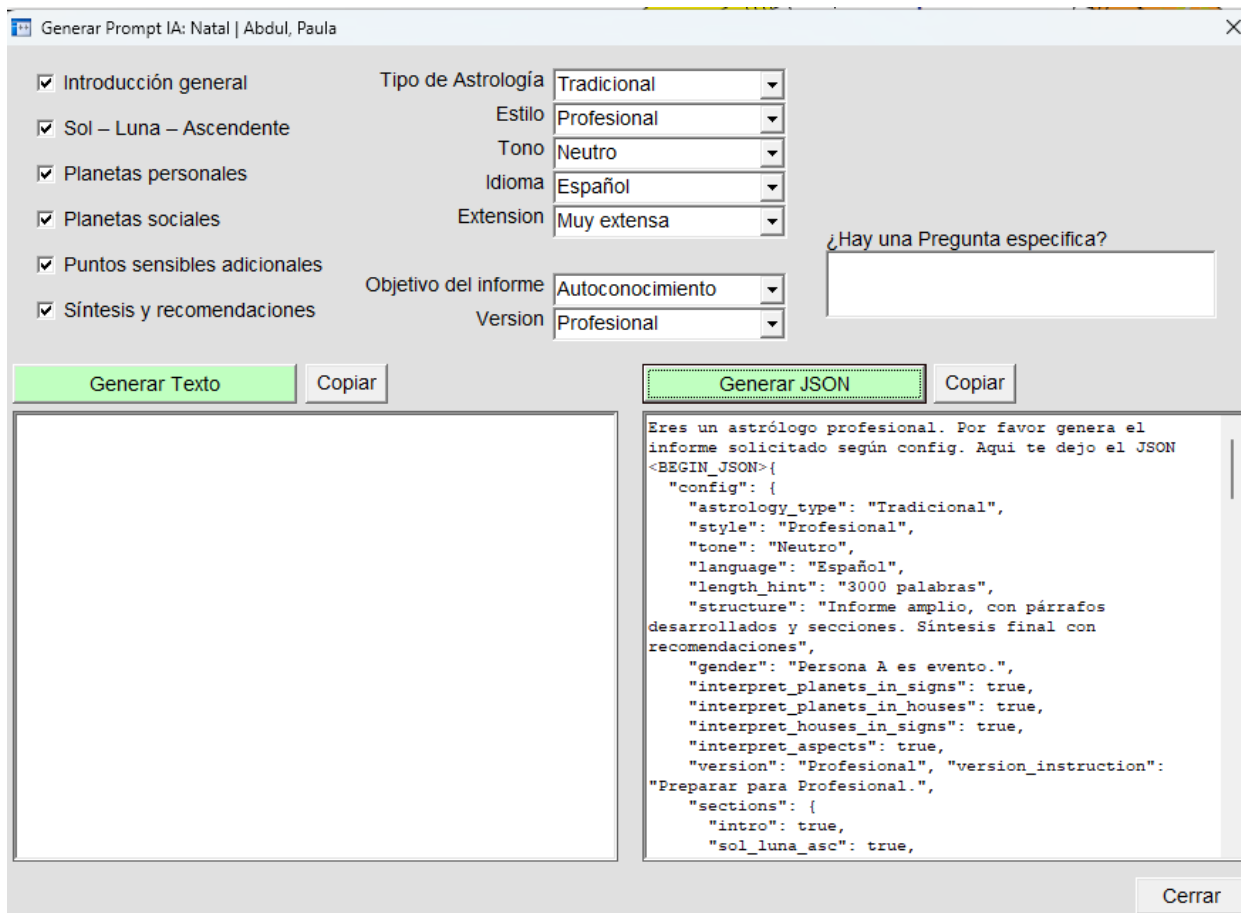

For advanced users who have connectors with different AI providers, it offers the possibility to use APIs such as OpenAI, Gemini and Anthropic, displaying the results directly within the program in a text editor.

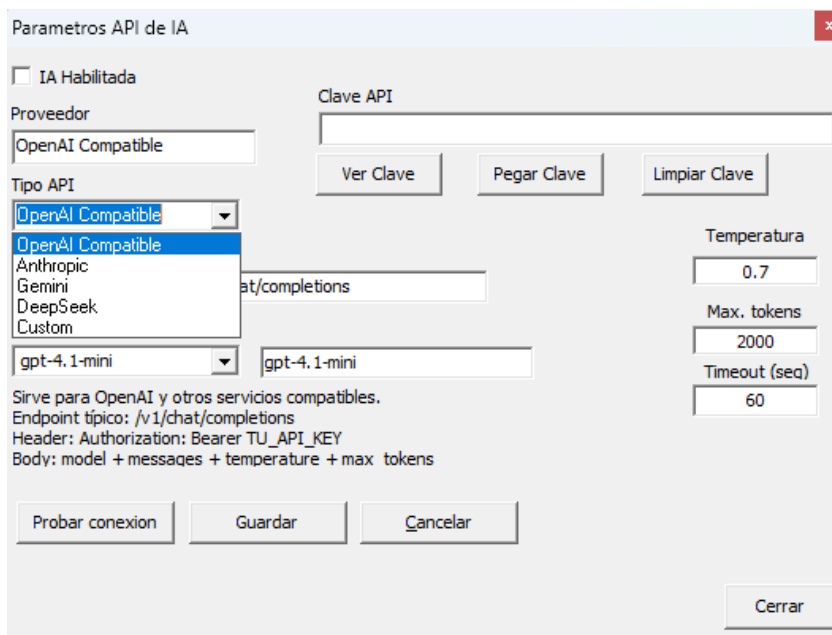

2. Tables of Planetary Revolutions of Mercury, Venus, Mars, Jupiter and Saturn (MAV9)

Added within Returns and Ingresses.

Allows the display of planetary revolutions as well as all direct and converse returns.

Each revolution can be visualized using the chronographic dial.

Tabla Revoluciones de Mercurio | Ejemplor1 | Todos | Mendoza/RA-Argentina [32.53.00 S|068.49.00 W]
20/02/2000 | HL 10:10:16 | DGMT+03:00:00
Mendoza/RA | S32.53.00|W068.49.00
Tropical | Geocéntrico ((C)Placidus

Edad	Mercurio en Casa	Ascendente		Asc. En Casa Natal	Júpiter		Júpiter en Casa	Júpiter en Casa Natal	Medio Cielo		MC En Casa Natal	Fecha	GMT	Int Días
0	12	7°15'56	↑	1	0°57' 4	♃	1	1	7°50'33	♃	10	20/02/2000G	13.10.16	43
0	10	4°12'14	↑	2	9°46' 4	♃	11	2	15°25'12	♃	12	03/04/2000G	14.62.37	360
1	11	14°19'45	↑	1	7°10'36	↑	2	3	15°32' 9	♃	10	29/03/2001G	11.15.00	358
2	11	15°49'55	↑	1	6°19'31	♃	3	3	17°11'15	♃	10	22/03/2002G	11.50.33	357
3	8	8°54'35	♃	4	8°42'54	♃	1	4	27°43' 4	↑	1	14/03/2003G	18.50.19	357
4	9	2° 4'33	♃	3	13°45'27	♃	2	6	20° 4' 1	↑	1	05/03/2004G	18.53.58	357
5	7	5°56'27	♃	4	17°58'42	♃	2	7	23°24'35	♃	2	25/02/2005G	21.35.59	359
5	5	17°59'49	♃	8	18°34'14	♃	1	8	1°44'44	♃	4	19/02/2006G	02.55.33	25
6	9	5°32'32	↑	2	18°38'23	♃	6	8	17° 8'47	♃	12	16/03/2006G	16.11.32	19
6	2	2°44' 0	♃	10	17°27'30	♃	10	8	23°29'43	♃	7	04/04/2006G	05.12.42	363
7	12	2° 7'58	↑	12	19°45'30	♃	9	9	2°17'56	♃	9	02/04/2007G	10.03.47	359
8	2	7°48'26	♃	10	19°26'39	♃	12	10	29°56'55	♃	7	26/03/2008G	06.10.27	357
9	7	5°50'38	♃	5	16°31'26	♃	6	11	15° 2' 4	↑	3	18/03/2009G	21.43.58	358
10	5	3°14'37	♃	7	12°17'20	♃	5	12	21° 0'42	♃	4	11/03/2010G	00.51.47	357
11	6	16°30'13	♃	7	8°13' 6	↑	6	1	10° 6'14	♃	4	03/03/2011G	00.37.25	357
12	2	22°17'35	♃	11	5°52'31	♃	3	2	17°46'58	♃	8	22/03/2012G	09.25.47	360
12	12	2°55'42	↑	12	6°52'28	↑	3	3	3° 9'24	♃	9	17/02/2013G	12.58.21	12
13	1	6°46'46	♃	11	7°47'50	♃	4	3	4°35' 8	♃	8	01/03/2013G	10.08.14	34
13	2	8°32' 7	♃	10	12°23'32	♃	5	3	0°52' 5	♃	7	04/04/2013G	05.39.24	360
14	9	10° 6'47	↑	3	11°22'22	♃	1	4	23° 1'30	♃	12	30/03/2014G	15.37.51	358
15	7	19°29'57	♃	5	12°59' 8	♃	12	5	3°52'15	↑	2	23/03/2015G	20.38.41	358
16	3	22°51'57	♃	10	17°25'26	♃	9	6	10°48'22	♃	7	15/03/2016G	05.41.57	357
17	3	24°59' 0	♃	10	21°51' 2	♃	10	7	13°32' 2	♃	7	07/03/2017G	06.24.25	357
18	2	6°45'57	♃	10	23° 4'15	♃	10	8	28°37'54	♃	7	27/02/2018G	07.53.17	358
19	4	24°58'55	♃	9	20°45'31	♃	12	9	6°35'19	♃	5	20/02/2019G	05.09.12	32
19	4	5°42'42	♃	9	23°51'59	♃	1	9	16°47'33	♃	5	24/03/2019G	01.47.14	9
19	1	26° 0'26	♃	11	24°14'22	♃	10	9	22°11'17	♃	8	02/04/2019G	07.12.59	366
20	12	19°57'49	♃	12	24°33'57	♃	11	10	19° 9' 5	♃	9	02/04/2020G	09.03.24	359
21	11	6°51'17	♃	2	22°20'37	♃	10	11	10° 0'42	♃	10	27/03/2021G	13.04.22	358
22	2	22°47'29	♃	11	18°31'40	♃	2	12	18°22'41	♃	8	20/03/2022G	07.47.38	357
23	12	13°30'35	♃	1	14°29'54	↑	1	1	14°38'16	♃	10	12/03/2023G	12.19.16	357
24	12	3° 2'42	↑	12	11°44'49	♃	2	2	3°16'57	♃	9	03/03/2024G	12.02.33	357
25	9	11°38'56	♃	3	11°54' 2	♃	1	3	24°53'19	♃	12	23/02/2025G	18.00.59	359
25	8	10°42'43	♃	4	15°49'21	♃	1	4	29°39'24	↑	1	17/02/2026G	20.34.16	18
26	3	17°28'55	♃	10	15° 6'44	♃	6	4	3°53'32	♃	6	07/03/2026G	05.49.41	28
26	9	6°38'13	♃	3	16° 2' 9	♃	2	4	18°33'20	♃	12	04/04/2026G	15.01.24	361
27	8	27°15'27	♃	4	17°14' 7	♃	1	5	15°55'37	♃	2	31/03/2027G	18.53.25	359
28	3	21°30'45	♃	10	21° 6'22	♃	9	6	9° 3'47	♃	7	24/03/2028G	04.59.46	357
29	9	7°49'36	♃	3	25°39'41	♃	5	7	20° 5'10	♃	12	16/03/2029G	16.20.39	

Tabla Revoluciones de Marte | Ejemplor1 | Todos | Mendoza/RA-Argentina [32.53.00 S|068.49.00 W]
20/02/2000 | HL 10:10:16 | DGMT+03:00:00
Mendoza/RA | S32.53.00|W068.49.00
Tropical | Geocéntrico ((C)Placidus

Edad	Marte en Casa	Ascendente		Asc. En Casa Natal	Venus		Venus en Casa	Venus en Casa Natal	Medio Cielo		MC En Casa Natal	Fecha	GMT	Int Días
0	12	7°15'56	↑	1	2°54' 9	♃	10	10	7°50'33	♃	10	20/02/2000G	13.10.16	707
1	10	17° 8'34	↑	3	10°55' 7	♃	8	11	1°58'36	↑	12	27/01/2002G	20.14.48	699
3	3	14°12'51	♃	11	7°42'37	♃	12	10	7°57'30	♃	8	27/12/2003G	12.35.18	542
5	9	27°16'56	↑	3	21°46'20	♃	1	4	14°26'34	↑	1	21/06/2005G	11.29.24	702
7	2	18°24' 8	♃	11	17° 8'40	♃	5	4	13° 5'32	♃	8	24/05/2007G	03.12.26	707
9	5	22°30'48	♃	8	2°16'45	↑	5	12	5°19'43	♃	4	30/04/2009G	22.30.02	710
11	11	9° 8'49	♃	2	17° 8' 2	♃	11	12	13°56'40	♃	11	10/04/2011G	12.27.20	710
13	11	18°33'55	♃	2	28° 5'48	♃	11	12	25°29'39	♃	11	20/03/2013G	14.33.09	710
15	2	10°20'35	♃	11	9°20'11	↑	2	1	8°34'38	♃	9	28/02/2015G	10.30.56	708
16	8	19°47'33	♃	4	1°44'12	↑	8	12	8°55'33	♃	2	05/02/2017G	21.56.29	704
18	12	16°31'31	↑	1	3°20'19	♃	8	8	17°57' 7	♃	10	10/01/2019G	16.33.26	546
20	2	4°23'48	♃	11	8°37'42	↑	4	3	1°53'19	♃	8	09/07/2020G	01.24.38	693
22	7	24°34'12	♃	5	5°56'12	♃	8	2	7°28'36	↑	3	02/06/2022G	16.13.32	707
24	4	13°38'39	♃	10	11°47'47	♃	5	2	29° 1' 0	♃	6	09/05/2024G	01.22.14	709
26	3	21°23'29	♃	10	22°39'19	♃	5	2	8°54'24	♃	7	18/04/2026G	03.22.56	710
28	4	1°51' 0	♃	9	23°52'40	♃	5	2	14°31'41	♃	6	28/03/2028G	03.13.59	710
30	4	27° 3'50	♃	9	1°29'15	♃	2	10	8°57' 3	♃	5	08/03/2030G	04.13.47	709
31	3	4°31' 4	♃	10	29° 0'44	♃	12	10	25°46'33	♃	7	15/02/2032G	08.31.10	706
33	12	27°25'47	↑	1	5°54'44	♃	10	10	0°11'44	♃	10	21/01/2034G	16.40.19	693
35	5	25°45'24	♃	8	25° 6'49	♃	3	10	8° 0'32	♃	4	15/12/2035G	07.41.45	546
37	8	19°40'29	♃	4	14°44'23	♃	12	4	8°48'32	♃	2	13/06/2037G	13.32.09	704
39	10	16°58'33	↑	3	12°19'39	♃	1	4	1°45'46	↑	12	18/05/2039G	12.57.26	708
41	6	17°36' 2	♃	8	25°26'15	♃	5	12	1°26'36	♃	4	25/04/2041G	22.32.45	710
43	9	25°50'13	↑	3	13°39'53	♃	9	12	12°42'20	↑	1	05/04/2043G	16.26.32	710
45	9	6°16'43	♃	3	24°47'18	♃	9	12	24°49'16	↑	1	15/03/2045G	18.32.10	710
47	2	5°29'11	♃	11	5°40'58	↑	2	12	3° 7'30	♃	8	23/02/2047G	10.26.37	708
48	4	28°26'29	♃	9	25°11'21	♃	4	12	10°32'19	♃	6	31/01/2049G	06.39.41	

Retorno-Marte[20] | Ejemplor1
 08/07/2020 - HL: 22°24'38"DSMT+03:00:00 - Mendoza/RA
 [01/10/2020C- HL: 00:00:00-Mendoza/RA]
 Placidus
 Standard orb. 100%

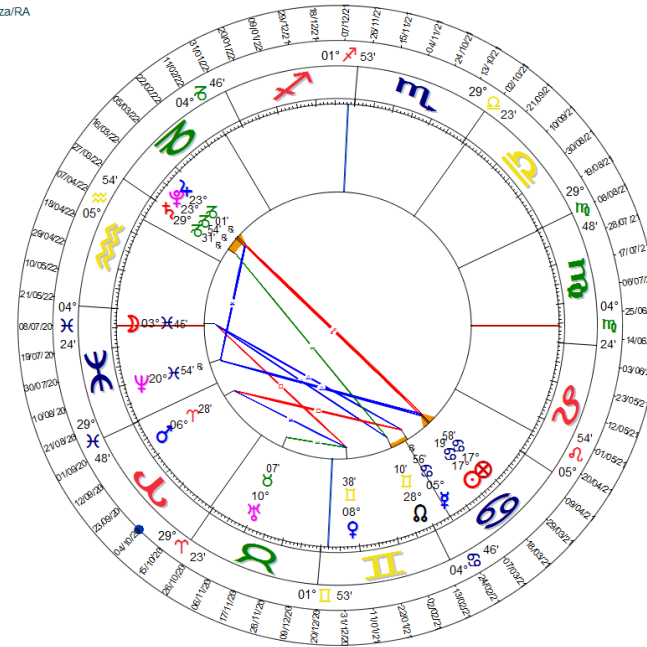

Cúspides Casas	
1	4°23'48" ♈
2	29°48'27" ♈
3	29°23'15" ♈
4	1°53'19" ♈
5	4°45'59" ♈
6	5°53'34" ♈
7	4°23'48" ♈
8	29°48'27" ♈
9	29°23'15" ♈
10	1°53'19" ♈
11	4°45'59" ♈
12	5°53'34" ♈

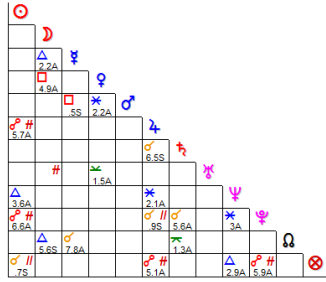

Asp. Mas Cercanos	
♈	0°32' S
♈	0°39' S
♈	0°53' S
♈	1°20' A
♈	1°30' A
♈	2°07' A
♈	2°10' A
♈	2°12' A
♈	2°56' A
♈	3°01' A
♈	3°35' A
♈	4°53' A
♈	5°03' A
♈	5°34' S
♈	5°36' A

Tabla Revoluciones de Júpiter | Ejemplor1 | Todos |Mendoza/RA-Argentina [32.53.00 S/068.49.00 W]

20/02/2000 | HL: 10:10:16 | DGMT+03:00:00
 Mendoza/RA | S32.53.00/W068.49.00
 Tropical | Geocéntrico ((C)Placidus

Edad	Júpiter en Casa	Ascendente	Asc. En Casa Natal	Mercurio	Mercurio en Casa	Mercurio en Casa Natal	Medio Cielo	MC En Casa Natal	Fecha	GMT	Int Días		
0	1	7°15'56"	♈	17°5'47"	♈	12	7°50'33"	♈	20/02/2000G	13:10:16	4127		
11	1	14°52'4"	♈	13°31'24"	♈	2	16°7'38"	♈	09/06/2011G	06:36:04	181		
11	4	20°31'30"	♈	7°45'42"	♈	11	7°47'37"	♈	07/12/2011G	12:00:14	37		
11	4	18°47'19"	♈	7°32'32"	♈	12	5°33'58"	♈	13/01/2012G	09:26:35	4145		
23	6	3°35'40"	♈	7°6'54"	♈	6	2	14°50'36"	♈	20/05/2023G	21:51:20	4366	
35	8	5°26'40"	♈	3°43'40"	♈	9	2	14°46'18"	♈	03/05/2035G	18:43:10	4367	
47	8	13°13'45"	♈	20°21'36"	♈	7	1	19°43'40"	♈	17/04/2047G	20:07:02	4367	
59	5	17°11'28"	♈	13°35'37"	♈	4	12	28°7'57"	♈	01/04/2059G	01:58:39	4364	
71	12	13°25'10"	♈	10°3'23"	♈	11	1	19°7'47"	♈	13/03/2071G	14:36:06	4131	
82	3	27°17'43"	♈	12°29'16"	♈	5	4	23°41'56"	♈	04/07/2082G	01:10:32	102	
82	3	26°7'17"	♈	15°25'2"	♈	8	7	22°19'19"	♈	14/10/2082G	18:19:57	128	
83	8	20°33'47"	♈	5	22°19'30"	♈	7	11	4°38'9"	♈	19/02/2083G	22:45:37	

Tabla Revoluciones de Júpiter | Ejemplor1

20/02/2000 | HL: 10:10:16 | DGMT+03:00:00
 Mendoza/RA | S32.53.00/W068.49.00
 Tropical | Geocéntrico ((C)Placidus

Edad	Júpiter en Casa	Ascendente	Asc. En Casa Natal	Mercurio	Mercurio en Casa	Mercurio en Casa Natal	Medio Cielo	MC En Casa Natal	Fecha	GMT	Int Días	
0	1	7°15'56"	♈	17°5'47"	♈	12	7°50'33"	♈	20/02/2000G	13:10:16	4127	
11	1	14°52'4"	♈	13°31'24"	♈	2	3	16°7'38"	♈	09/06/2011G	06:36:04	4363
23	6	3°35'40"	♈	7°6'54"	♈	6	2	14°50'36"	♈	20/05/2023G	21:51:20	4366
35	8	5°26'40"	♈	3°43'40"	♈	9	2	14°46'18"	♈	03/05/2035G	18:43:10	4367
47	8	13°13'45"	♈	20°21'36"	♈	7	1	19°43'40"	♈	17/04/2047G	20:07:02	4367
59	5	17°11'28"	♈	13°35'37"	♈	4	12	28°7'57"	♈	01/04/2059G	01:58:39	4364
71	12	13°25'10"	♈	10°3'23"	♈	11	1	19°7'47"	♈	13/03/2071G	14:36:06	4131
82	3	27°17'43"	♈	12°29'16"	♈	5	4	23°41'56"	♈	04/07/2082G	01:10:32	

Tabla Revoluciones de Saturno | Ejemplor1 | Todos |Mendoza/RA-Argentina [32.53.00 S/068.49.00 W]

20/02/2000 | HL: 10:10:16 | DGMT+03:00:00
 Mendoza/RA | S32.53.00/W068.49.00
 Tropical | Geocéntrico ((C)Placidus

Edad	Saturno en Casa	Ascendente	Asc. En Casa Natal	Sol	Sol en Casa	Sol en Casa Natal	Medio Cielo	MC En Casa Natal	Fecha	GMT	Int Días	
0	2	7°15'56"	♈	11°12'7"	♈	11	11	7°50'33"	♈	20/02/2000G	13:10:16	10644
29	12	21°42'13"	♈	22°55'4"	♈	11	1	29°26'1"	♈	12/04/2029G	13:17:20	10629
58	1	28°6'14"	♈	28°39'33"	♈	2	2	0°58'7"	♈	19/05/2058G	08:58:51	10642
87	11	17°24'51"	♈	16°30'59"	♈	1	4	2°18'31"	♈	08/07/2087G	09:37:24	97
87	4	11°0'54"	♈	20°36'26"	♈	9	7	3°58'56"	♈	13/10/2087G	17:12:12	164
88	1	27°30'5"	♈	5°50'33"	♈	12	12	0°16'42"	♈	25/03/2088G	12:29:19	

3. Hermetic Astrology (MAV9)

Based on the work of Elbert Benjamine (Brotherhood of Light), *Astrodyne Manual (1950)*.

Allows the determination of planetary strength (Astrodynes) and the balance between harmony and disharmony (Harmodynes and Discordynes).

Available in Natal Chart

Astrología Hermética

- C1 Astrodinas Natal
- C2 Astrodinas Progresión Secundaria
- C3 Astrodinas Progresión Menor
- C4 Astrodinas Tránsito

Natal

Astrodinas Natal | Ejemplor1
 20/02/2000 | HL:10:10:16 | DGMT+03:00:00
 Mendoza/RA | 532.53.00/W068.49.00
 Tropical | Geocéntrico | (C)Placidus

Meridian Pro Gold 8.413 - www.catharsoftware.com

Planeta	Fuerza	%	A/D	Orden Fuerza			
				Fuerza	Fuerza	Fuerza	Fuerza
♂	63.21	12.20	-0.87	♂	♂	♂	♂
♂	60.79	11.73	20.76	♂	♂	♂	♂
♂	48.13	9.29	-6.64	♂	♂	♂	♂
♂	45.21	8.73	7.90	♂	♂	♂	♂
♂	44.30	8.55	16.18	♂	♂	♂	♂
♂	44.22	8.54	-5.80	♂	♂	♂	♂
♂	43.60	8.42	0.45	♂	♂	♂	♂
♂	43.12	8.32	-5.98	♂	♂	♂	♂
♂	39.99	7.72	15.59	♂	♂	♂	♂
♂	37.54	7.25	-8.64	♂	♂	♂	♂
♂	31.10	6.00	1.80	♂	♂	♂	♂
♂	16.82	3.25	0.93	♂	♂	♂	♂
Total	518.02		35.70				

Planeta	Fuerza	%	A/D	Orden Armonia			
				A/D	A/D	A/D	A/D
♂	60.79	11.73	20.76	♂	♂	♂	♂
♂	44.30	8.55	15.19	♂	♂	♂	♂
♂	39.99	7.72	15.59	♂	♂	♂	♂
♂	45.21	8.73	7.90	♂	♂	♂	♂
♂	31.10	6.00	1.80	♂	♂	♂	♂
♂	16.82	3.25	0.93	♂	♂	♂	♂
♂	43.60	8.42	0.45	♂	♂	♂	♂
♂	63.21	12.20	-0.87	♂	♂	♂	♂
♂	44.22	8.54	-5.80	♂	♂	♂	♂
♂	43.12	8.32	-5.98	♂	♂	♂	♂
♂	48.13	9.29	-6.64	♂	♂	♂	♂
♂	37.54	7.25	-8.64	♂	♂	♂	♂
Total	518.02		35.70				

Signo	Fuerza	%	A/D	Casa	Fuerza	%	A/D
♈	129.83	16.76	-9.57	Casa 10	153.19	19.83	18.35
♈	118.32	15.31	25.71	Casa 1	146.10	18.91	16.99
♈	114.03	14.76	30.66	Casa 12	113.84	14.73	-4.61
♈	109.62	14.19	16.78	Casa 9	73.99	9.58	10.83
♈	73.99	9.58	10.83	Casa 11	68.80	8.90	17.21
♈	63.68	8.24	-5.74	Casa 6	59.10	7.65	-11.63
♈	59.10	7.65	-11.63	Casa 2	53.24	6.89	9.90
♈	22.15	2.87	8.10	Casa 7	22.15	2.87	8.10
♈	21.95	2.84	-1.34	Casa 8	21.95	2.84	-1.34
♈	21.56	2.79	-2.99	Casa 3	21.56	2.79	-2.99
♈	20.00	2.59	7.80	Casa 5	20.00	2.59	7.80
♈	18.77	2.43	-4.32	Casa 4	18.77	2.43	-4.32
Total	772.69		64.28	Total	772.69		64.28

Signo	Fuerza	%	A/D	Casa	Fuerza	%	A/D
♈	114.03	14.76	30.66	Casa 10	153.19	19.83	18.35
♈	118.32	15.31	25.71	Casa 11	68.80	8.90	17.21
♈	109.62	14.19	16.78	Casa 1	146.10	18.91	16.99
♈	73.99	9.58	10.83	Casa 9	73.99	9.58	10.83
♈	22.15	2.87	8.10	Casa 2	53.24	6.89	9.90
♈	20.00	2.59	7.80	Casa 7	22.15	2.87	8.10
♈	21.95	2.84	-1.34	Casa 5	20.00	2.59	7.80
♈	21.56	2.79	-2.99	Casa 8	21.95	2.84	-1.34
♈	18.77	2.43	-4.32	Casa 3	21.56	2.79	-2.99
♈	63.68	8.24	-5.74	Casa 4	18.77	2.43	-4.32
♈	129.53	16.76	-9.57	Casa 12	113.84	14.73	-4.61
♈	59.10	7.65	-11.63	Casa 6	59.10	7.65	-11.63
Total	772.69		64.28	Total	772.69		64.28

Signos	Fuerza	A/D	Casas	Fuerza	A/D
Fuego	223.52	9.05	Personal	334.75	19.28
Tierra	236.81	13.29	Amistad	120.01	-0.05
Aire	43.71	5.11	Comunidad	317.94	45.05
Agua	150.34	11.12	Vitalidad	240.09	35.62
Cardinal	234.13	-11.53	Éxito	265.53	16.62
Fijo	274.30	62.82	Relaciones	112.51	22.32
Mutuable	264.27	12.99	Psiquismo	154.56	-10.27
Masculino	385.55	39.87	Norte	318.77	15.75
Femenino	387.15	24.41	Sur	453.92	48.53
			Este	556.73	54.84
			Oeste	215.96	9.44

	Dominante			Mejor		
	Pla	Sig	Cas	Pla	Sig	Cas
1	♂	♈	10	♂	♈	10
2	♂	♈	1	♂	♈	11
3	♂	♈	12	♂	♈	1

Orden Fuerza

	Dig. -2.00	Dig. 1.00	Dig. 2.00	Dig. 1.00	Dig. 2.00														
☉																			
☽																			
♃																			
♄																			
♅																			
♆																			
♇																			
♈																			
♉																			
♊																			
♋																			
♌																			
♍																			
♎																			
♏																			
♐																			
♑																			
♒																			
♓																			
♈																			

Synastry

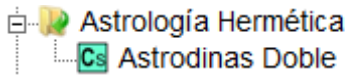

Astrodinas Doble

Ejemplor1
 20/02/ 2000G-GMT:13:10:16
 S 32 53.00 / W 068.49.00
 Mendoza/RA

Meridian Pro Gold 8.413 - www.catharsoftware.com

Ejemplor2
 01/10/ 2020G- HL:00:00:00
 S 32 53.00 / W 068.49.00
 Mendoza/RA

Orden Fuerza

Planeta	Fuerza	%	A/D	Fuerza	Fuerza	Fuerza	Fuerza
♃	63.21	12.20	-0.87	♃	♄	♅	♆
♄	60.79	11.73	20.76	♄	♅	♆	♇
♅	48.13	9.29	-6.64	♅	♆	♇	♈
♆	45.21	8.73	7.00	♆	♇	♈	♉
♇	44.30	8.55	16.19	♇	♈	♉	♊
♈	44.22	8.54	-5.80	♈	♉	♊	♋
♉	43.60	8.42	0.45	♉	♊	♋	♌
♊	43.12	8.32	-5.98	♊	♋	♌	♍
♋	39.99	7.72	15.59	♋	♌	♍	♎
♌	37.54	7.25	-8.64	♌	♍	♎	♏
♍	31.10	6.00	1.80	♍	♎	♏	♐
♎	16.82	3.25	0.93	♎	♏	♐	♑
♏				♏	♐	♑	♒
♐				♐	♑	♒	♓
♑				♑	♒	♓	
♒				♒	♓		
♓				♓			
Total	518.02		35.73	♃	♄	♅	♆

Planeta	Fuerza	%	A/D	Fuerza	Fuerza	Fuerza	Fuerza
♃	52.98	11.55	9.37	♃	♄	♅	♆
♄	47.27	10.31	2.33	♄	♅	♆	♇
♅	45.88	10.01	17.25	♅	♆	♇	♈
♆	44.37	9.68	5.20	♆	♇	♈	♉
♇	43.88	9.57	-0.52	♇	♈	♉	♊
♈	42.89	9.35	-20.92	♈	♉	♊	♋
♉	40.06	8.74	-16.02	♉	♊	♋	♌
♊	37.37	8.15	-1.02	♊	♋	♌	♍
♋	33.39	7.28	0.72	♋	♌	♍	♎
♌	27.49	6.00	-19.35	♌	♍	♎	♏
♍	23.02	5.02	-4.43	♍	♎	♏	♐
♎	19.92	4.34	6.55	♎	♏	♐	♑
♏				♏	♐	♑	♒
♐				♐	♑	♒	♓
♑				♑	♒	♓	
♒				♒	♓		
♓				♓			
Total	458.52		-20.84	♃	♄	♅	♆

Signo	Fuerza	%	A/D	Casa	Fuerza	%	A/D
♈	129.53	16.76	-9.57	Casa 10	153.19	19.83	18.35
♉	118.32	15.31	25.71	Casa 11	146.10	18.91	16.99
♊	114.03	14.76	30.86	Casa 12	113.84	14.73	-4.61
♋	109.62	14.19	16.78	Casa 9	73.99	9.58	10.83
♌	73.99	9.58	10.83	Casa 11	68.80	8.90	17.21
♍	63.68	8.24	-5.74	Casa 6	59.10	7.65	-11.63
♎	59.10	7.65	-11.63	Casa 2	53.24	6.99	9.90
♏	22.15	2.87	8.10	Casa 7	22.15	2.87	8.10
♐	21.95	2.84	-1.34	Casa 8	21.95	2.84	-1.34
♑	21.56	2.79	-2.99	Casa 3	21.56	2.79	-2.99
♒	20.00	2.59	7.80	Casa 5	20.00	2.59	7.80
♓	18.77	2.43	-4.32	Casa 4	18.77	2.43	-4.32
Total	772.69		64.28	Total	772.69		64.28

Signo	Fuerza	%	A/D	Casa	Fuerza	%	A/D
♈	149.86	22.44	-7.31	Casa 10	159.43	23.87	20.20
♉	122.06	18.28	21.22	Casa 8	149.86	22.44	-7.31
♊	101.70	15.23	32.40	Casa 11	87.35	13.08	36.81
♋	61.02	9.14	-7.35	Casa 1	61.02	9.14	-7.35
♌	49.19	7.36	-24.71	Casa 4	47.13	7.06	-8.95
♍	43.35	6.49	4.00	Casa 5	37.45	5.61	-16.07
♎	36.61	5.48	6.92	Casa 3	36.61	5.48	6.92
♏	32.98	4.94	-1.15	Casa 7	22.94	3.43	8.62
♐	22.94	3.43	8.62	Casa 6	21.69	3.25	-5.36
♑	18.68	2.80	-0.51	Casa 2	18.68	2.80	-0.51
♒	15.77	2.36	-5.11	Casa 9	15.77	2.36	-5.11
♓	13.75	2.06	-9.67	Casa 12	9.96	1.49	3.28
Total	667.90		-47.45	Total	667.90		-47.45

Signos	Fuerza	A/D	Casas	Fuerza	A/D
Fuego	223.52	9.05	Personal	334.75	19.28
Tierra	236.81	13.29	Amistad	120.01	-0.05
Aire	43.71	5.11	Comunidad	317.94	45.05
Agua	150.34	11.12	Vitalidad	240.09	35.62
Cardinal	234.13	-11.63	Éxito	265.53	16.62
Fijo	274.30	62.82	Relaciones	112.61	22.32
Mutabile	264.27	12.99	Psiquismo	154.56	-10.27
Masculino	385.55	39.87	Norte	318.77	15.75
Femenino	387.15	24.41	Sur	453.92	48.53
			Este	556.73	54.84
			Oeste	215.96	9.44



Signos	Fuerza	A/D	Casas	Fuerza	A/D
Fuego	161.25	-16.85	Personal	126.27	2.34
Tierra	196.58	-18.14	Amistad	129.22	-21.75
Aire	104.37	-3.34	Comunidad	412.41	-28.03
Agua	189.93	-4.00	Vitalidad	114.24	-28.53
Cardinal	313.59	-36.22	Éxito	199.81	14.33
Fijo	134.54	-24.06	Relaciones	146.90	-20.27
Mutabile	219.77	12.83	Psiquismo	206.95	-12.98
Masculino	281.39	-25.31	Norte	222.59	-31.31
Femenino	386.52	-22.13	Sur	445.31	-16.13
			Este	373.05	-13.27
			Oeste	294.85	-34.18

	Dominante			Mejor		
	Pla	Sig	Cas	Pla	Sig	Cas
1	♃	♄	10	♃	♄	10
2	♄	♅	1	♄	♅	11
3	♅	♆	12	♅	♆	1

	Dominante			Mejor		
	Pla	Sig	Cas	Pla	Sig	Cas
1	♃	♄	10	♃	♄	10
2	♄	♅	8	♄	♅	7
3	♅	♆	11	♅	♆	3

4. Solar Return with Annual Solar Arc Progression and Lunar Return with Lunar Arc Progression (MAV9)

New tool that integrates Solar Return with annual Solar Arc progression and Lunar Return with Lunar Arc progression, allowing a more dynamic and precise approach to forecasting.

-  Retorno-Sol con Progresión Arco
-  Retorno-Luna con Progresión Arco

Retorno-Sol con Progresión Arco | Malena B
 20/12/1985 | HL:20:00:00 | DGMT:+03:00:00
 San Miguel-RA | S34.33.00 /W058.43.00
 Orbe en grados 1
 03/12/2020 | GMT: 23:00:00

Meridian Pro Gold 8.426 - www.catharsoftware.com

Posiciones 03/12/2020
 GMT: 23:00:00

Longitud	Deccl.
12°14'43"	-21°14'57"
8°40'26"	9°31'39"
0°53'00"	-18°50'11"
14°22'55"	-21°26'09"
4°22'43"	-12°20'55"
17°24'45"	-22°36'45"
3°22'41"	-23°16'50"
16°3'46R	6°18'07"
29°18'49"	-11°41'55"
5°15'51"	-23°18'03"
21°40'13R	23°09'40"
0°35'07"	23°26'08"
11°42'00"	-4°37'35"
14°41'23"	-6°01'18"
12°44'11"	-3°22'32"
10°41'58"	-22°02'53"

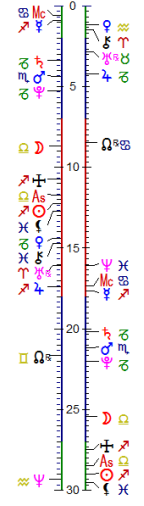
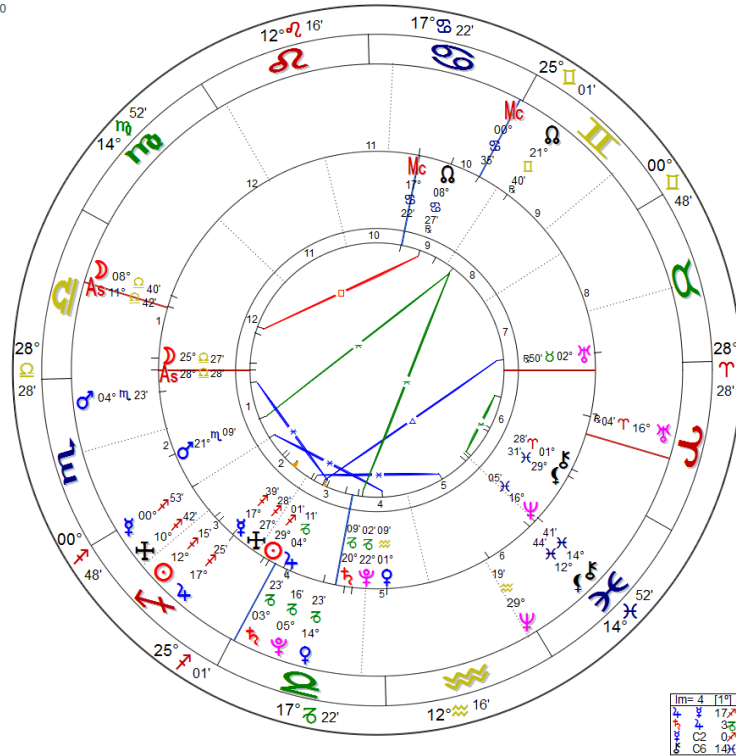



Casas Placidus

1	11°41'50"	♏
2	14°1'54"	♏
3	8°14'45"	♏
4	0°35'11"	♏
5	25°29'43"	♏
6	28°5'33"	♏
7	11°41'50"	♏
8	14°1'54"	♏
9	8°14'45"	♏
10	0°35'11"	♏
11	25°29'43"	♏
12	28°5'33"	♏

lm=	4	19°
4	8	17°
5	2	3°
6	C2	0°
8	OS	14°

5. Atacirs in Solar and Lunar Returns (MAV9)

Incorporates the use of Atacirs within Solar and Lunar Returns, enabling the timing of events through directed movements within the chart.

-  Atacir / Retorno Solar
-  Atacir / Retorno Lunar

Atacir / Retorno Solar-C1 | Malena B
 20/12/1985 | HL:20:00:00 | DGMT:+03:00:00
 San Miguel-RA | S34.33.00 / W058.43.00
 Orbe en grados 1
 03/12/2020 | GMT: 23:00:00

Meridian Pro Gold 8.426 - www.catharsoftware.com

Posiciones 03/12/2020
 GMT: 23:00:00

Longitud	Decil.
12°45'33"	-21°18'52"
9°11'16"	9°19'45"
1°23'50"	-18°56'24"
14°53'45"	-21°22'47"
4°53'33"	-12°31'14"
17°55'35"	-22°39'32"
3°53'31"	-23°15'57"
16°34'36R	6°29'57"
29°49'39"	-11°31'07"
5°46'41"	-23°16'43"
22°41'38"	23°11'30"
1°5'57"	23°25'54"
12°12'50"	-4°49'36"
15°12'13"	-5°49'23"
13°15'1"	-3°10'48"
11°12'48"	-22°07'10"

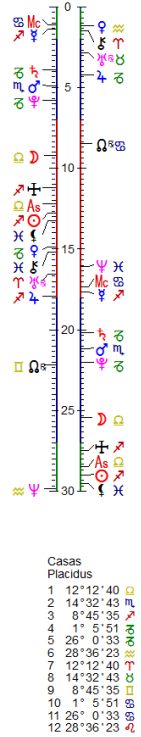
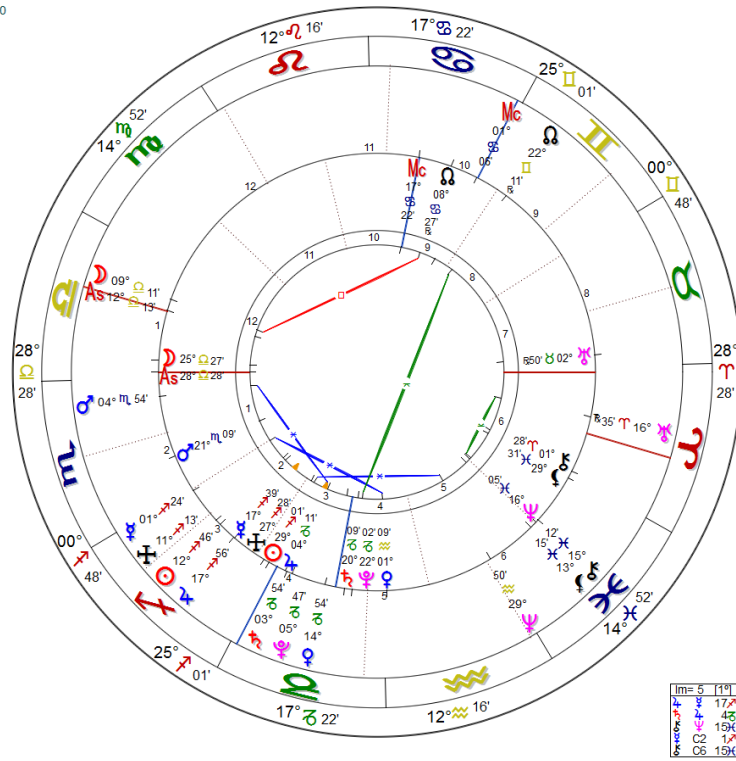

6. Synodic Lunar Return (E. Linares)

Based on the work of Mexican astrologer Enrique Linares.

Uses the synodic cycle of the Moon to calculate the Lunar Return, offering an alternative approach to traditional methods.

Retorno Sinódico Lunar (E. Linares) | Abbado, Claudio
19/04/ 2026G - HL:21:43:11-DGMT-01:00:00 -Milano (Milan)I
[26/06/ 1933G- HL:02:00:00-Milano (milan)I]
Placidus
Standard orb, 100%

Meridian Pro Gold 9.009 - www.catharsoftware.com

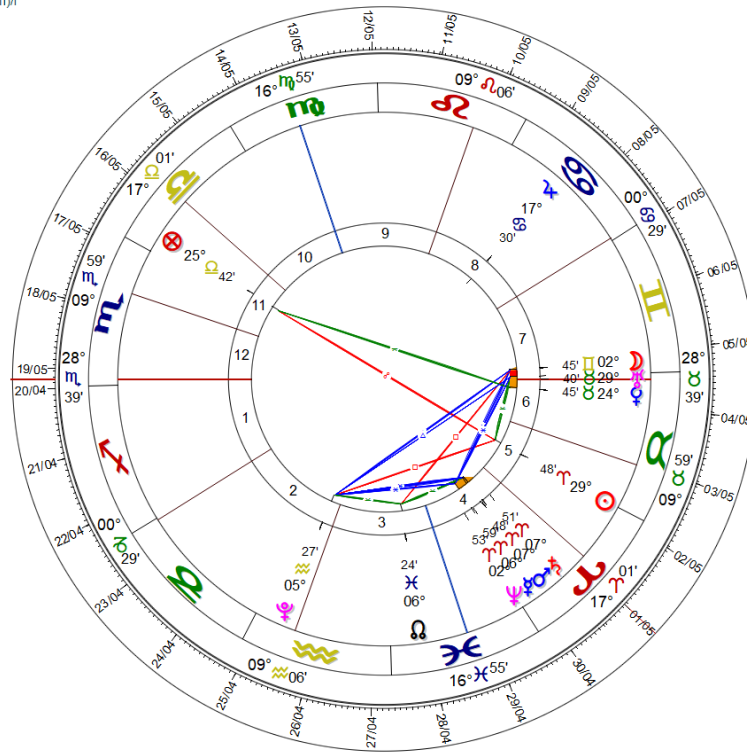

7. Astrocartography Display in Spherical Mode, Fixed Stars and Animation Panel (MAV9)

New astrocartography presentation in spherical mode, including the integration of Fixed Stars and an Animation Panel for dynamic visualization.

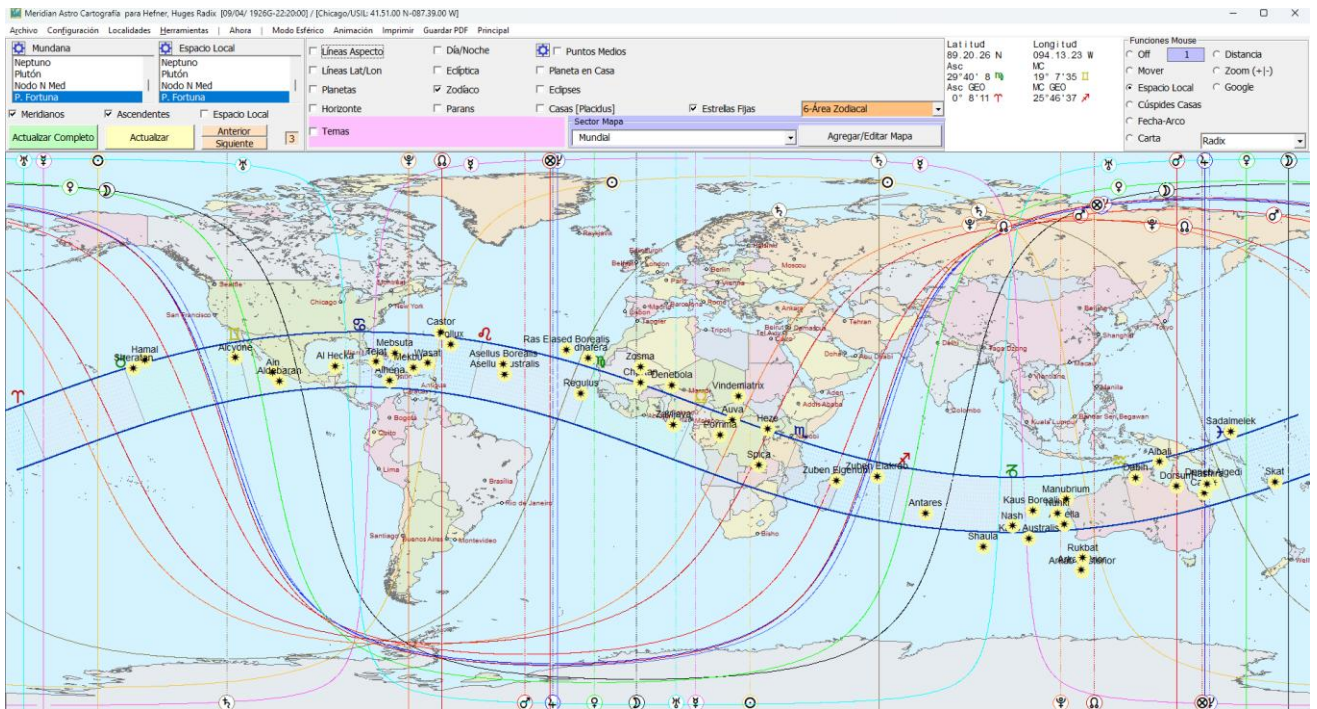
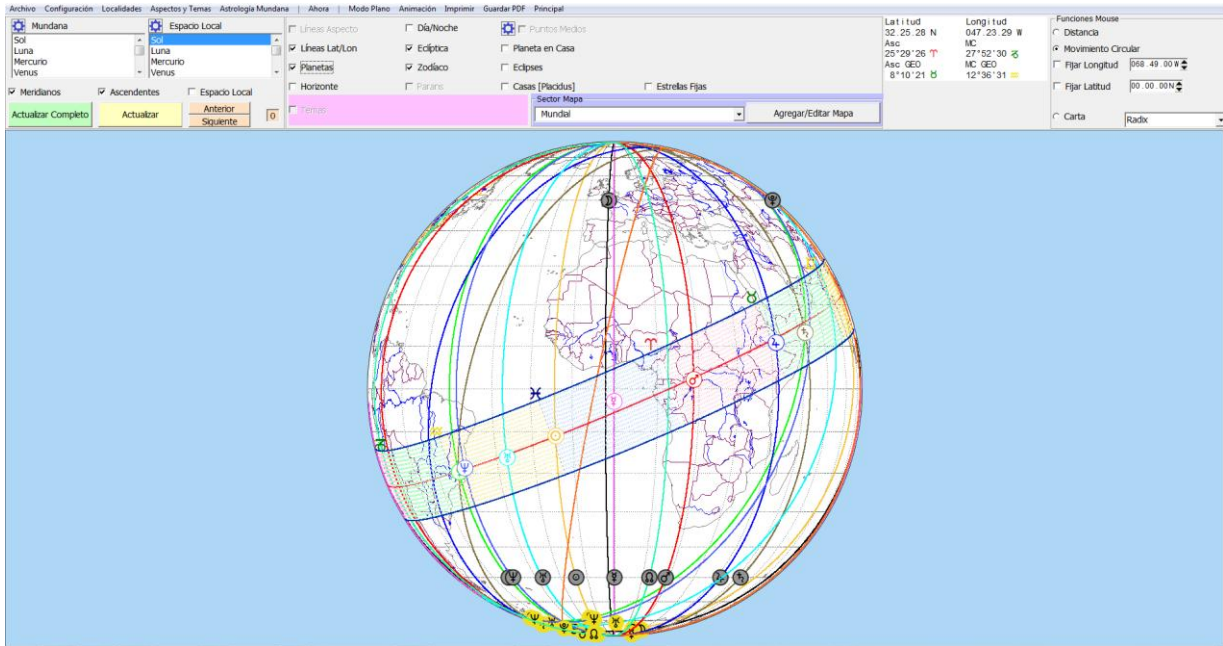

8. Transits, Progressions and Cartography Cycle with Animation (MAV9)

New tool that integrates Transits, Progressions and Cartography cycles with animation. Includes the option to overlay natal and forecast charts..

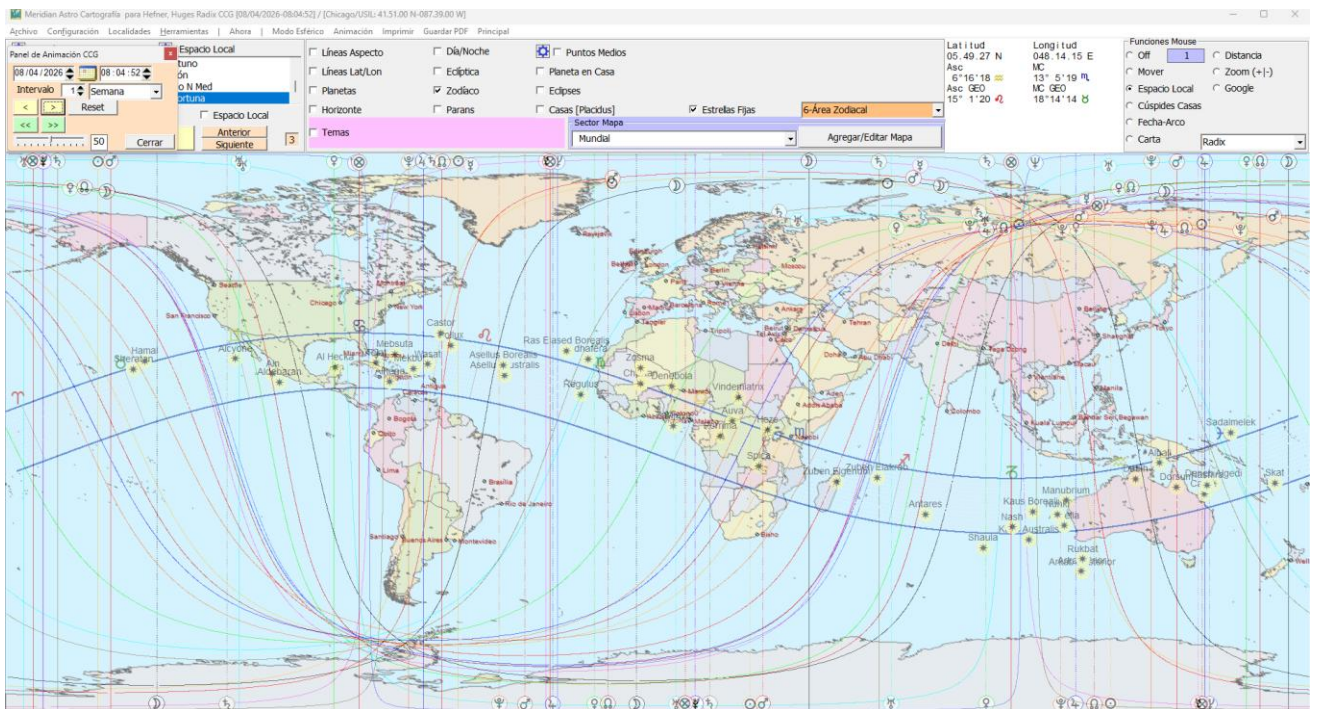
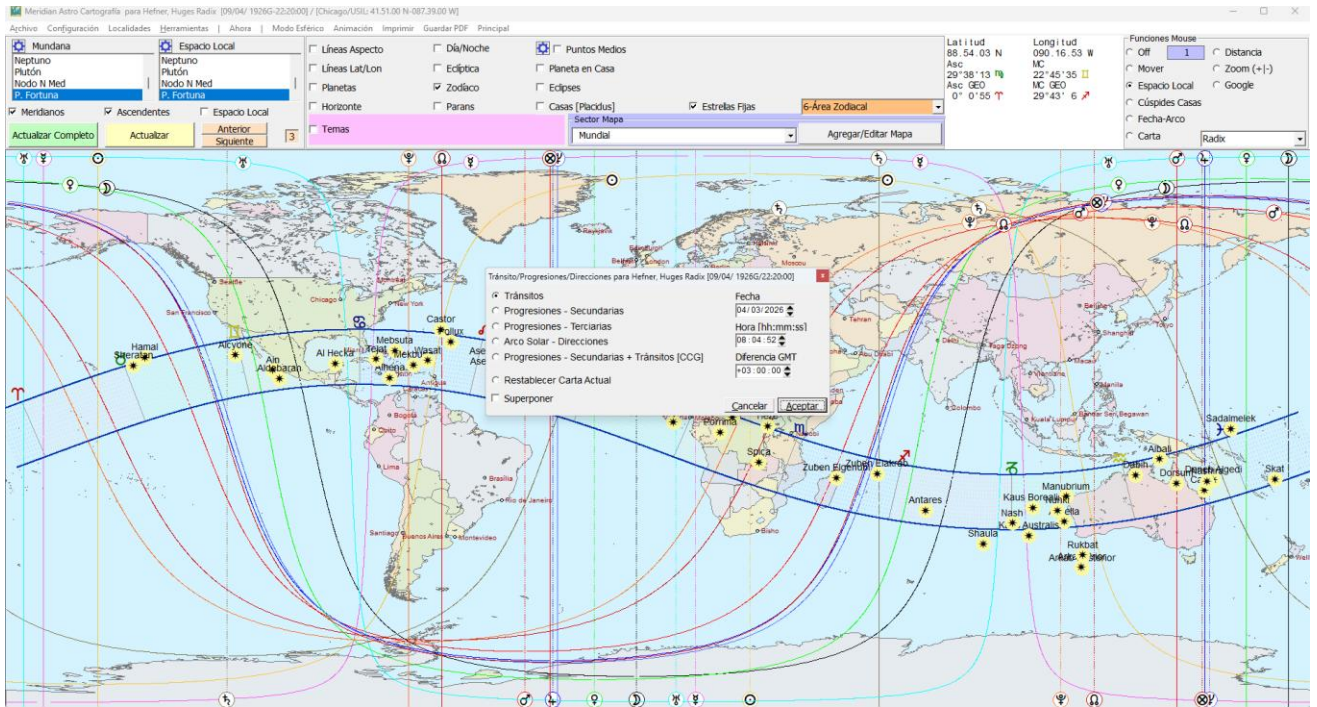

9. Austral Chart (MAV9)

Based on the work of Argentine astrologer Daniel Serra.

Available in the Natal Menu Tree.

Carta Austral (D. Serra) | Abdul, Paula
 19/06/ 1962G | HL:14:32:00 | DGMT:+07:00:00
 Los Angeles/USCA | N34.03.00/W118.14.00
 Tropical | Geocéntrico | (C)Placidus

Meridian Pro Gold 9.001 - www.catharssoftware.com

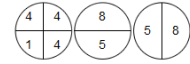

Zodiaco	
♈	Aries
♉	Tauro
♊	Géminis
♋	Cáncer
♌	Leo
♍	Virgo
♎	Libra
♏	Escorpio
♐	Sagitario
♑	Capricornio
♒	Acuario
♓	Piscis

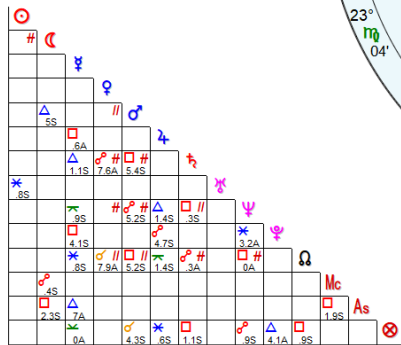
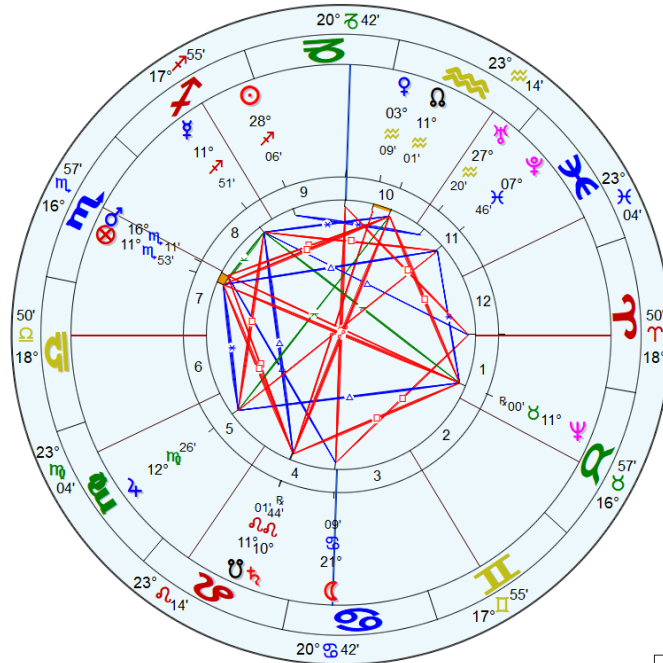

Aspectos	
☉	000°00' Conjunción
☽	030°00' Semisextil
♃	060°00' Sextil
♁	090°00' Cuadratura
♅	120°00' Trígono
♄	150°00' Quincuncio
♂	180°00' Oposición
	Paralelo
#	C. Paralelo

Planetas	
☉	Sol
☽	Luna
☿	Mercurio
♀	Venus
♂	Marte
♃	Júpiter
♁	Saturno
♅	Urano
♆	Neptuno
♇	Plutón
♊	Nodo N Med
♋	Nodo S Med
♁	Medio Cielo
♁	Ascendente
♁	P. Fortuna

10. Simple Chart Design Tool with up to 6 Additional Dials (MAV9)

Allows the creation of customized chart designs, incorporating up to six additional dials for advanced visualization and analysis.

Archivo Principal

Círculo Interno Círculo Aspectos Planetas Círculo Zodiacal Círculo Casas **Anillo Adicional** Reiniciar

Mostrar Anillo Adicional
 Círculo Externo

Marcas de Grado 1° 5° 10°
 Círculo Doble .001

Círculo Interno

Marcas de Grado 1° 5° 10°
 Círculo Doble .001

Dodecatemoria

Regencia

Términos

Faces

Triplidad

Exaltación

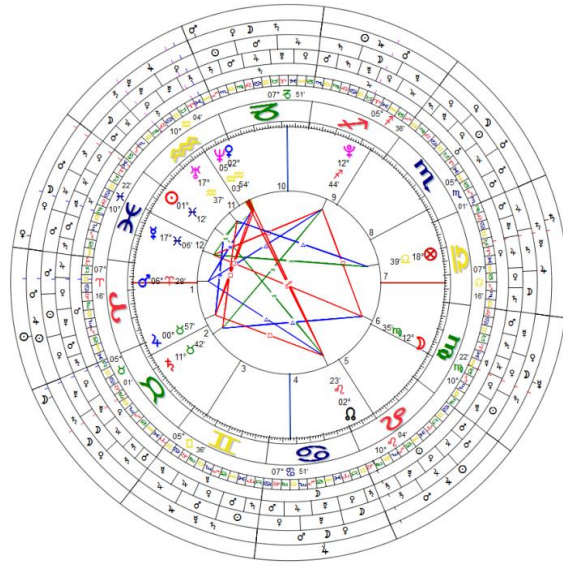

11. Conjunction Impact Analysis Tool in Forecasting / Radix Techniques with Configurable Orb (MAV9)

Provides analysis of conjunction impact across forecasting techniques and Radix charts, with a configurable orb to adjust sensitivity.

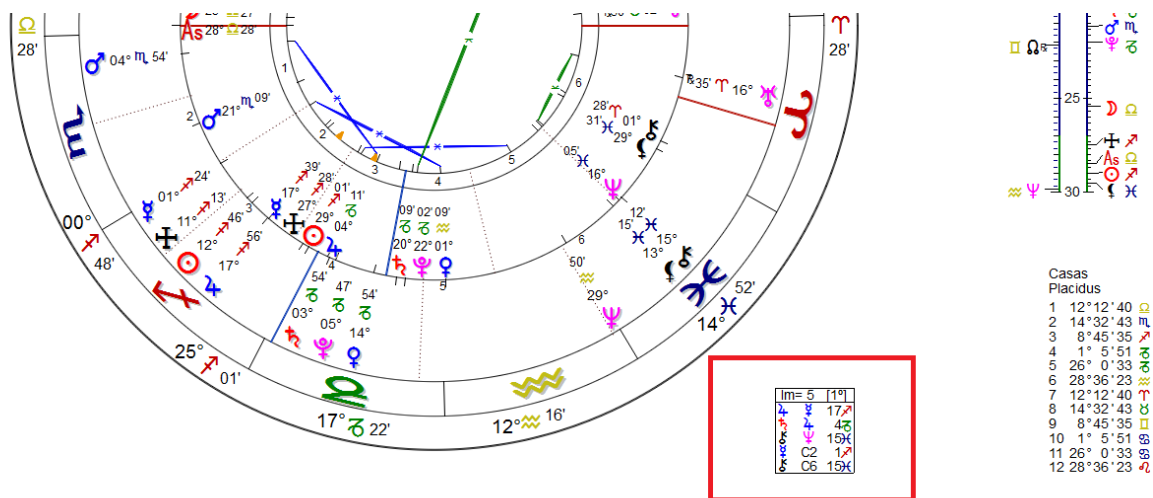

12. Conjunction Impact Analysis Tool in Forecasting / Radix Techniques with Configurable Orb (MAV9)

Provides analysis of conjunction impact across forecasting techniques and Radix charts, with a configurable orb to adjust sensitivity.

Opciones	▶
Orbe	▶
Tabla de Aspectos	
Mostrar Flor Armónica	
Mostrar Astrodinas	
Reporte Mensual de Impactos	
Imprimir	▶
Guardar Como PDF	

Reporte Mensual de Impactos | Atacar / Retorno Solar - Diciembre 2020 | Malena B

Sábado	Domingo	Lunes	Martes	Miércoles	Jueves	Viernes
			1 2	2 2	3 4	4 5
			C4 28 ♂ C4 27 ♀	C4 4 ♀ C4 29 ♂	17 ♀ 4 ♀ C2 0 ♀ C6 14 ♀	17 ♀ 4 ♀ 15 ♀ C2 1 ♀ C6 15 ♀
5 3	6 4	7 4	8 2	9 3	10 4	11 6
4 ♀ 16 ♀ C6 14 ♀	15 ♀ C4 17 ♀ C9 24 ♀ C6 15 ♀	16 ♀ C4 17 ♀ C9 25 ♀ 4 ♀	C4 17 ♀ 4 ♀	17 ♀ 20 ♀ C5 1 ♀	20 ♀ 17 ♀ C2 20 ♀ C5 1 ♀	21 ♀ 8 ♀ 17 ♀ C3 24 ♀ C10 21 ♀ 8 ♀
12 5	13 2	14 1	15 2	16 4	17 6	18 7
22 ♀ C3 25 ♀ C10 17 ♀ 8 ♀	27 ♀ C3 17 ♀	27 ♀	28 ♀ C4 17 ♀	29 ♀ C3 24 ♀ C7 28 ♀ C4 17 ♀	25 ♀ C3 25 ♀ C4 17 ♀ C1 25 ♀	19 ♀ 25 ♀ 29 ♀ C4 17 ♀ C3 25 ♀ C1 25 ♀
19 4	20 33	21 37	22 1	23 8	24 12	25 4
27 ♀ 20 ♀ 29 ♀ C6 14 ♀	26 ♀ 25 ♀ 17 ♀ 0 ♀ 20 ♀ 3 ♀ 19 ♀ 2 ♀	15 ♀ 21 ♀ 8 ♀ 17 ♀ 28 ♀ 1 ♀ 29 ♀ 27 ♀	29 ♀ 29 ♀ 12 ♀ 29 ♀ 6 ♀ 22 ♀ 0 ♀	0 ♀ 0 ♀ 7 ♀ 18 ♀ 24 ♀ 20 ♀ 15 ♀	27 ♀ C3 18 ♀ C4 19 ♀ 0 ♀ 22 ♀ C12 14 ♀ C1 27 ♀ C1 14 ♀ C1 0 ♀ C1 27 ♀ C1 0 ♀	27 ♀ C1 18 ♀ C3 27 ♀ C4 20 ♀
26 1	27 5	28 4	29 0	30 0	31 1	
4 ♀ 29 ♀	18 ♀ 0 ♀ C6 26 ♀ C4 22 ♀	18 ♀ 0 ♀ C6 26 ♀ C4 22 ♀			C4 15 ♀	

15. New Points Added (MAV9)

The following selectable points have been added:

- Haumea Asteroid
- Makemake Asteroid
- Parental Syzygy Position
- Prenatal New Moon
- Prenatal Full Moon
- Prenatal Solar Eclipse
- Prenatal Lunar Eclipse
- Venus Star Point
- Mercury Star Point
- Hypothetical Vulcan Point (Intermercurial)
- Solar Apex
- Psyche Asteroid
- Stationary Mercury Position

16. Venus Star Pentagram Tool (MAV9)

Based on the work of Arielle Guttman, *Venus Star Point*.

Includes Report mode presentation and Dynamic pentagram with transits

Informe Estrella Venus | Bautista
 15/07/2011G | HL:20:15:00 | DGMT+03:00:00
 Buenos Aires/RA | S34:36:00/W058:26:00
 Tropical | Geocéntrico (C)Koch

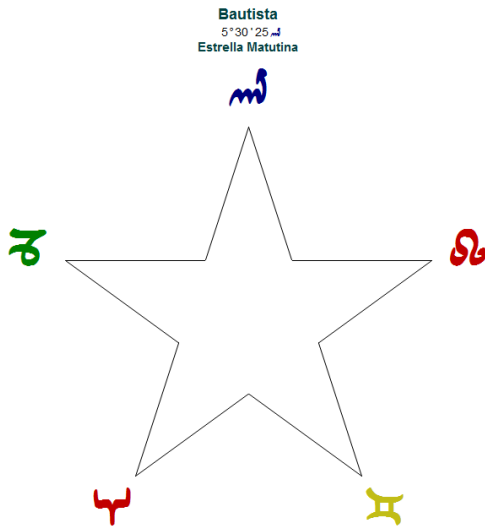

Fecha	Hora	Posición	EV
11/01/2010G	21:06:10	21°32'16"	EV
29/10/2010G	01:10:15	5°30'25"	EM
16/08/2011G	12:08:04	23°17'48"	EV
06/06/2012G	01:08:58	15°44'46"	EM
28/03/2013G	17:05:14	8°10'37"	EV
11/01/2014G	12:24:27	21°11'59"	EV
25/10/2014G	07:31:14	1°48'32"	EV
15/08/2015G	19:21:38	22°39'06"	EM
06/06/2016G	21:49:52	16°35'48"	EV
25/03/2017G	10:17:07	4°57'13"	EM
09/01/2018G	07:02:06	18°57'29"	EV
26/10/2018G	14:16:06	3°06'30"	EM
14/08/2019G	06:07:28	21°11'23"	EV
03/06/2020G	17:43:30	13°35'40"	EM
26/03/2021G	06:58:03	5°50'29"	EV
09/01/2022G	00:47:25	18°43'08"	EM
22/10/2022G	21:17:31	29°26'54"	EV
13/08/2023G	11:15:25	20°28'13"	EM
04/06/2024G	15:33:40	14°29'50"	EV
23/03/2025G	01:07:18	2°39'06"	EM
06/01/2026G	16:36:11	16°22'05"	EV
24/10/2026G	03:43:55	0°45'02"	EM
12/08/2027G	00:20:55	19°06'41"	EV
01/06/2028G	09:59:59	11°26'19"	EM
23/03/2029G	20:11:58	3°28'55"	EV
06/01/2030G	13:17:19	16°15'55"	EM
20/10/2030G	11:12:26	27°06'25"	EV
11/08/2031G	03:00:29	18°17'13"	EM
02/06/2032G	09:07:26	12°23'33"	EV
04/01/2034G	02:10:08	13°46'24"	EV
21/10/2034G	17:03:37	28°22'30"	EM
09/08/2035G	18:40:01	17°01'40"	EV
30/05/2036G	02:24:34	9°16'35"	EM
21/03/2037G	09:15:34	1°05'40"	EV
04/01/2038G	01:26:34	13°46'05"	EM
18/10/2038G	01:40:19	24°46'57"	EV
08/08/2039G	19:01:47	16°06'26"	EM
31/05/2040G	02:24:39	10°15'41"	EV
18/03/2041G	06:45:53	28°02'22"	EM
01/01/2042G	12:16:24	11°12'31"	EV
19/10/2042G	06:28:48	26°00'32"	EM
07/08/2043G	12:39:49	14°56'00"	EV
27/05/2044G	18:41:40	7°06'59"	EM
18/03/2045G	22:23:01	28°43'36"	EV
01/01/2046G	13:35:09	11°17'24"	EM
15/10/2046G	16:01:28	22°28'09"	EV
06/08/2047G	11:03:35	13°56'54"	EM
28/05/2048G	19:50:59	8°09'17"	EV
15/03/2049G	21:28:54	25°43'55"	EM
29/12/2049G	21:52:53	8°37'15"	EV
16/10/2050G	20:01:17	23°39'31"	EM
05/08/2051G	06:56:56	12°51'17"	EV
25/05/2052G	10:59:21	4°56'56"	EV
16/03/2053G	14:04:00	26°14'18"	EV

Pentagrama Estrella Venus | Paula Abdul
 19/06/1962G | HL:14:32:00 | DGMT+07:00:00
 Los Angeles/USCA | N34:03:07/W118:14:33
 Tropical | Geocéntrico (C)Placidus

05/11/2022

Fecha

DIA

+ 1 | - 1

SEMANA

+ 1 | - 1

MES

+ 1 | - 1

AÑO

+ 1 | - 1

OTRA

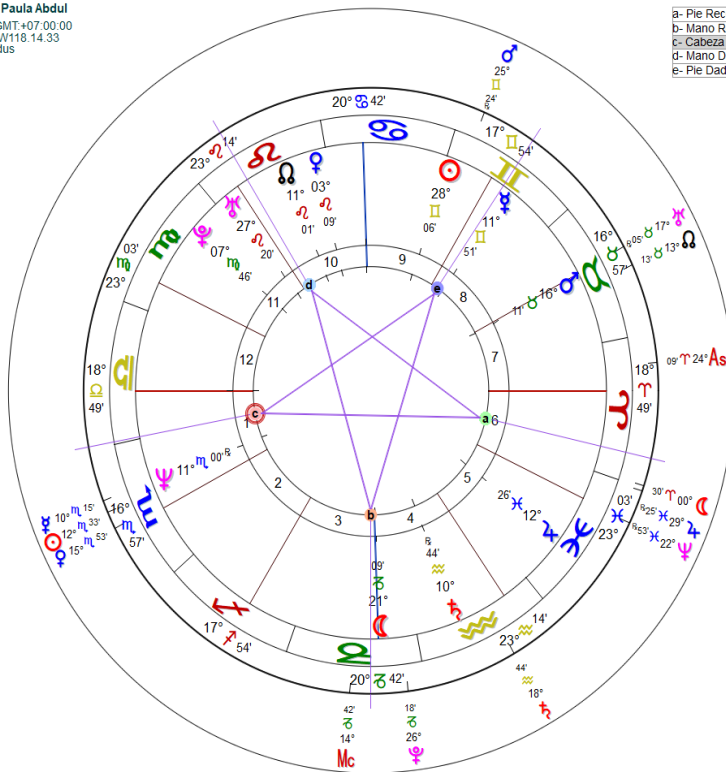

a- Pie Receptor	25/03/2021G	23:58:03	5°50'29"	EV
b- Mano Receptora	08/01/2022G	16:47:25	18°43'08"	EM
c- Cabeza	22/10/2022G	14:17:31	29°26'54"	EV
d- Mano Dadora	13/08/2023G	04:15:25	20°28'13"	EM
e- Pie Dador	04/06/2024G	08:33:40	14°29'50"	EV

17. Relationship Venus Star Pentagram Tool (MAV9)

Also based on Arielle Guttman's *Venus Star Point*.

Includes Report mode presentation and Dynamic pentagram with transits

Pentagrama Estrella Venus - Relación: Paula Abdul y Boris Becker

Meridian Pro Gold 8.506 - www.catharsoftware.com

Becker, Boris
22/11/1967G-GMT: 7:45:00
N 49.21.00 / E. 008.41.00
Leimen Bei Karlsruhe

Relacion Kármica / Evolutiva y Armonizante

Abdul, Paula
19/06/1962G-GMT:21:32:00
N 34.03.00 / W 118.14.00
Los Angeles/USCA

Fecha	Hora	Posición	☾	♁	♂	♂	♂	♂	♂	♂	♂	♂	♂	♂	♂
26/01/1966G	00:37:23	5°56'51" EM													
08/11/1966G	16:40:05	16°09'40" EV													
29/08/1967G	14:40:20	5°50'59" EM													
20/09/1968G	03:21:57	29°07'52" EV													
08/04/1969G	07:10:19	18°36'08" EV													
24/01/1970G	12:27:18	4°27'06" EV													
10/11/1970G	00:48:51	17°32'47" EM													
27/08/1971G	11:54:05	3°50'43" EV													
17/06/1972G	08:08:31	26°30'09" EV													
09/04/1973G	11:13:26	19°47'39" EV													

Fecha	Hora	Posición	☾	♁	♂	♂	♂	♂	♂	♂	♂	♂	♂	♂	♂
22/06/1960G	09:24:49	1°13'16" EV													
10/04/1961G	15:50:32	20°51'40" EV													
27/01/1962G	02:19:20	7°00'19" EV													
12/11/1962G	12:06:28	19°57'42" EV													
29/08/1963G	18:30:47	5°58'29" EV													
19/06/1964G	15:40:07	28°38'15" EM													
11/04/1965G	20:21:11	22°03'05" EV													
26/01/1966G	00:37:23	5°56'51" EM													
08/11/1966G	16:40:05	16°09'40" EV													
29/08/1967G	14:40:20	5°50'59" EM													

☾	29	18		
☾	26	47		
♂	10	41	□	3.7S
♂	13	13	△	6.2S
♂	22	41		
♂	4	25		
♂	5	54R	✳	1.1S
♂	28	22		
♂	24	16R		
♂	22	32	□	.5S
♂	27	27R		
♂	6	2	△	1S
♂	9	22	✳	2.4S
♂	6	51	♂	.2S
♂	5	50		

☾	28	5		
☾	21	8	□	.3S
♂	11	51	□	6S
♂	3	9		
♂	16	10		
♂	12	26	♂	6.6S
♂	10	44R		
♂	27	19		
♂	11	0R		
♂	7	46	♂	1.9S
♂	9	28R		
♂	20	42		
♂	18	49		
♂	11	52	△	6S
♂	7	0R		

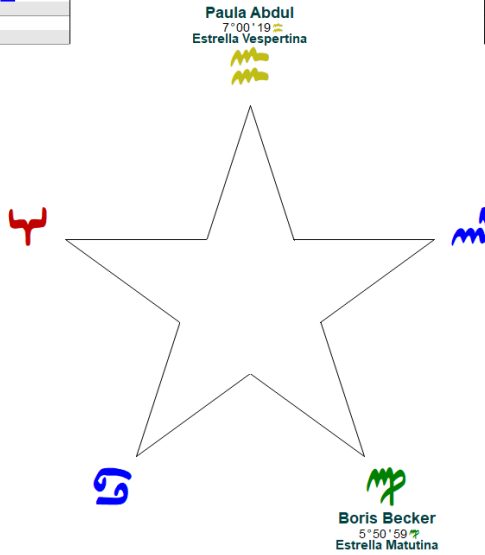

Pentagrama Estrella Venus - Relación: Paula Abdul y Woody Allen

Abdul, Paula
19/06/1962G-GMT:21:32:00
N 34.03.07 / W 118.14.33
Los Angeles/USCA

Allen, Woody
02/12/1935G-GMT: 3:55:00
N 40.42.50 / W 074.00.23

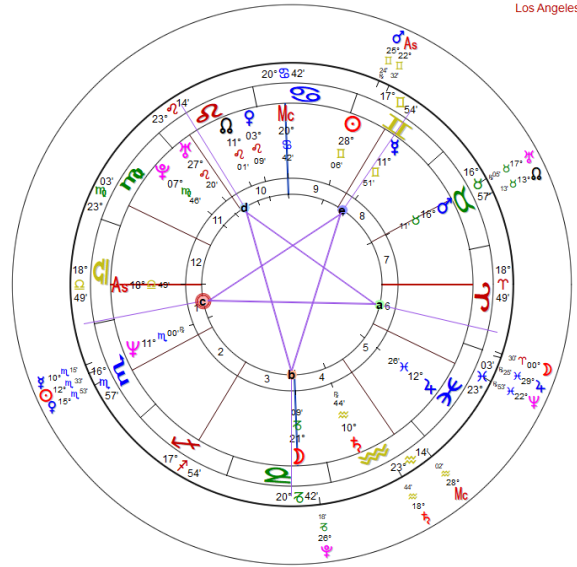
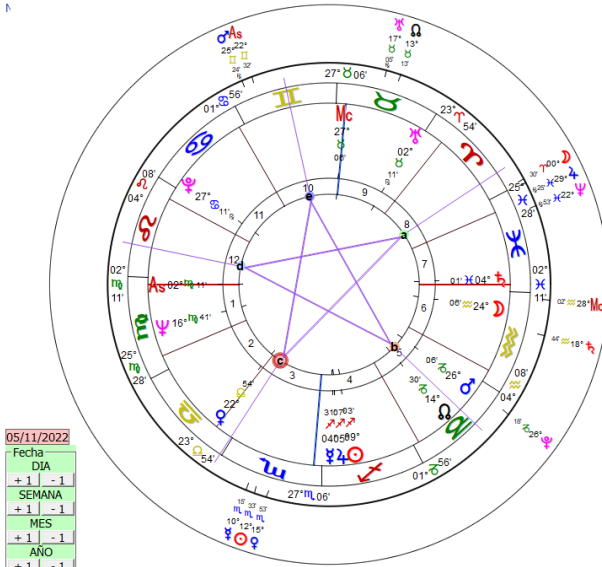

05/11/2022
Fecha
DIA
+1 -1
SEMANA
+1 -1
MES
+1 -1
AÑO
+1 -1
OTRA

a- Pie Receptor	25/03/2021G	23:58:03	5°50'29" ↑	EV
b- Mano Receptora	08/01/2022G	16:47:25	18°43'08" ↘	EM
c- Cabeza	22/10/2022G	14:17:31	29°26'54" ↘	EV
d- Mano Dadora	13/08/2023G	04:15:25	20°28'13" ↓	EM
e- Pie Dador	04/06/2024G	08:33:40	14°29'50" ↑	EV

a- Pie Receptor	25/03/2021G	23:58:03	5°50'29" ↑	EV
b- Mano Receptora	08/01/2022G	16:47:25	18°43'08" ↘	EM
c- Cabeza	22/10/2022G	14:17:31	29°26'54" ↘	EV
d- Mano Dadora	13/08/2023G	04:15:25	20°28'13" ↓	EM
e- Pie Dador	04/06/2024G	08:33:40	14°29'50" ↑	EV

18. Mercury Star Report Tool (MAV9)

Includes Report mode presentation and Dynamic pentagram with transits

Año Elemental de Mercurio | Paula Abdul
 19/06/1962G | HL: 14:32:00 | DGMT+07:00:00
 Los Angeles/USCA | N34.03.07W/118.14.33
 Tropical | Geocéntrico | (C)Placidus

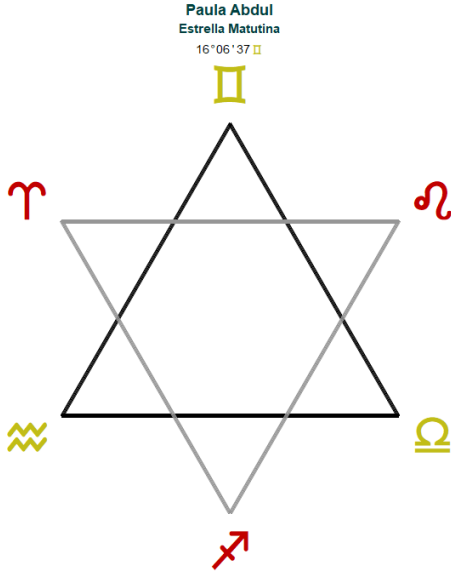

Fecha	Hora	Posición	
16/07/1960G	17:33:50	24°25'43" ♄	EM
30/08/1960G	16:33:29	7°33'53" ♃	EV
07/11/1960G	08:39:37	15°16'37" ♃	EM
05/01/1961G	15:06:10	16°23'56" ♄	EV
21/02/1961G	15:34:32	3°07'13" ♃	EM
01/05/1961G	16:17:17	11°19'25" ♄	EV
27/06/1961G	04:42:03	5°34'14" ♄	EM
14/08/1961G	07:56:29	21°33'54" ♃	EV
22/10/1961G	10:58:45	29°08'12" ♃	EM
16/12/1961G	00:04:20	24°08'13" ♃	EV
05/02/1962G	05:18:31	16°16'07" ♄	EM
15/04/1962G	18:28:38	25°37'47" ♃	EV
07/06/1962G	01:21:37	16°06'37" ♿	EM
29/07/1962G	08:14:00	6°00'37" ♃	EV
06/10/1962G	08:48:58	12°54'37" ♃	EM
25/11/1962G	01:36:22	2°38'13" ♃	EV
20/01/1963G	03:07:11	29°40'12" ♄	EM
30/03/1963G	14:25:19	9°29'56" ♃	EV
17/05/1963G	20:10:35	26°28'41" ♄	EM
13/07/1963G	14:30:45	20°45'17" ♄	EV
19/09/1963G	21:47:08	26°30'38" ♃	EM
04/11/1963G	17:07:53	11°53'26" ♃	EV
04/01/1964G	06:17:10	13°15'19" ♄	EM
12/03/1964G	23:56:40	22°46'27" ♃	EV
27/04/1964G	03:10:17	7°10'16" ♄	EM
27/06/1964G	00:25:01	5°39'37" ♄	EV
02/09/1964G	00:02:15	9°49'42" ♃	EM
15/10/1964G	11:44:05	22°26'22" ♃	EV
18/12/1964G	12:35:50	26°58'43" ♃	EM
23/02/1965G	19:06:52	5°18'01" ♃	EV
08/04/1965G	05:25:47	18°29'49" ♃	EM
11/06/1965G	12:01:48	20°37'02" ♃	EV
15/08/1965G	12:10:50	22°43'11" ♃	EM
27/09/1965G	07:27:20	4°15'50" ♃	EV
02/12/1965G	20:04:52	10°47'08" ♃	EM
05/02/1966G	18:53:40	16°52'08" ♄	EV
26/05/1966G	23:37:34	5°31'49" ♃	EM
28/07/1966G	06:42:54	5°01'43" ♃	EV
10/09/1966G	00:21:45	17°08'20" ♃	EM
17/11/1966G	02:58:04	24°38'50" ♃	EV
17/01/1967G	18:11:05	27°17'18" ♄	EM
03/03/1967G	23:36:03	13°02'01" ♃	EV
11/05/1967G	09:25:05	20°17'10" ♄	EM
09/07/1967G	05:02:52	16°35'46" ♄	EV
24/08/1967G	08:51:18	0°47'21" ♃	EM
01/11/1967G	07:27:54	8°31'05" ♃	EV
28/12/1967G	15:18:11	6°32'24" ♄	EM
15/02/1968G	07:15:37	26°00'38" ♄	EV
24/04/1968G	14:36:23	4°47'25" ♄	EM
18/06/1968G	08:48:19	27°26'18" ♃	EV
07/08/1968G	04:24:43	14°59'54" ♃	EM
15/10/1968G	08:40:27	22°20'36" ♃	EV
06/12/1968G	18:31:18	15°03'31" ♃	EV
20/01/1969G	09:49:05	03°47'10" ♃	EV

Año Elemental de Mercurio | Paula Abdul
 19/06/1962G | HL: 14:32:00 | DGMT+07:00:00
 Los Angeles/USCA | N34.03.07W/118.14.33
 Tropical | Geocéntrico | (C)Placidus

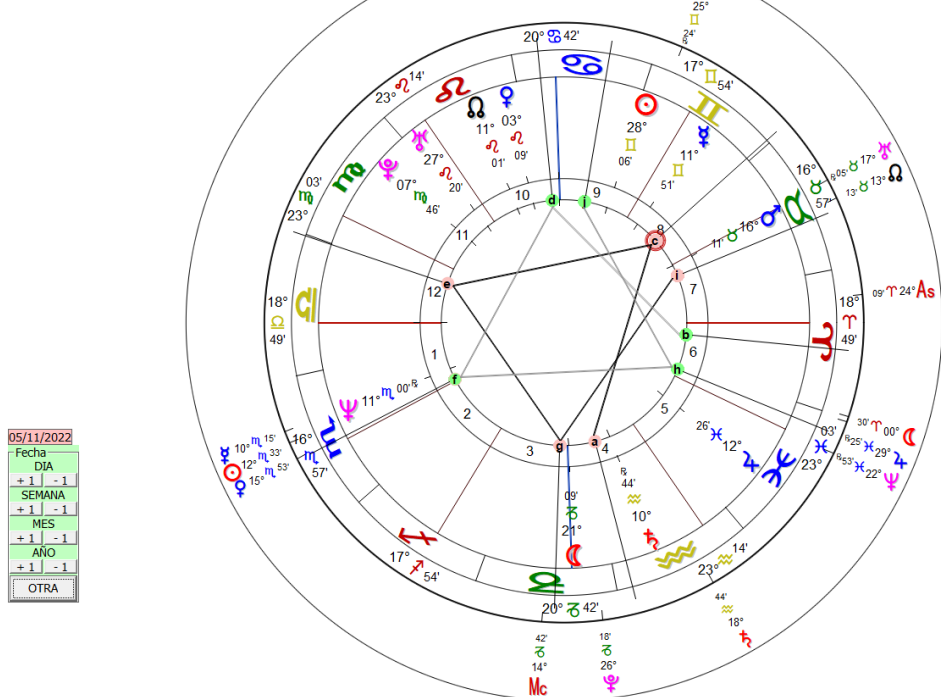

a-	23/01/2022G	02:28:02	3°22'59" ♄	EM
b-	02/04/2022G	16:10:45	13°11'09" ♃	EV
c-	21/05/2022G	12:17:55	0°43'06" ♃	EM
d-	16/07/2022G	12:37:34	24°15'19" ♃	EV
e-	22/09/2022G	23:49:46	0°14'07" ♃	EM
f-	08/11/2022G	08:42:48	16°15'09" ♃	EV
g-	07/01/2023G	04:56:51	16°56'50" ♄	EM
h-	17/03/2023G	03:44:32	25°34'23" ♃	EV
i-	01/05/2023G	16:27:26	11°19'48" ♄	EM
j-	30/06/2023G	22:05:38	9°08'45" ♄	EV

05/11/2022

Fecha

DIA +1 | -1

SEMANA +1 | -1

MES +1 | -1

AÑO +1 | -1

OTRA

19. Mercurial Types Tool (MAV9)

Based on the work of Antonio Polito.
 Classifies different Mercurial typologies for analysis.

Tipos Mercuriales - Polito - Radix | Paula Abdul
 19/06/1962G | HL: 14:32:00 | DGMT:+07:00:00
 Los Angeles/USCA | N34.03.07/W118.14.33
 Tropical | Geocéntrico | (C)Placidus

Tipo Mercurial	ANTE PROMETEICO
Distancia Sol - Mercurio	016°14'40
Longitud	V.Lg°/d]
☉ 28°05'50	0°57'15
♁ 11°51'11	0°02'38

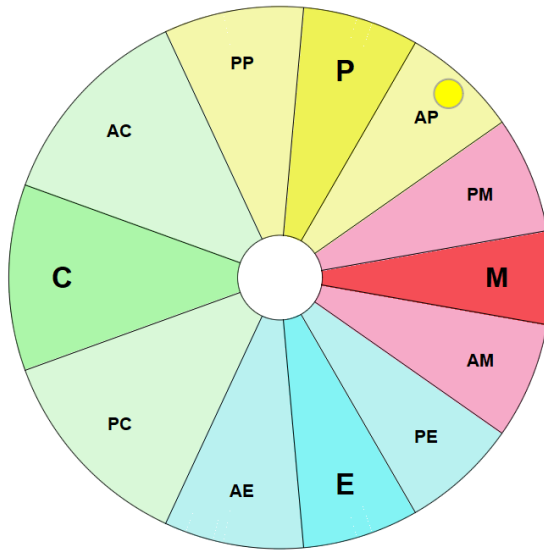

Les interesa formarse una idea del desenlace de la situación actual. Anticipan desenlaces. Adivinan. Confían en sus experiencias y conocimientos acumulados. Usan presentimientos para anticipar los hechos. Nada les sorprende, actúan como si ya supieran lo que va a ocurrir. Creen en las corazonadas. No le dan importancia a las explicaciones si de hecho han acertado. Es en primer lugar prometeico y en segundo lugar manifiesta tendencias de modelador. Tienen respuesta para todo, son de mente rápida y segura. Se dan un tiempo para aprender pero luego aplican de manera práctica sus conocimientos para conseguir resultados de manera rápida y segura.

20. Pregnancy Almuten (Omar Tiberiades) (MAV9)

Tool designed to determine the ruling planet in pregnancy-related analysis.

Radix-Almuten de Embarazo (Omar Tiberiades)

Regen: Ptolomeo, Exalt: Ptolomeo, Trip: Doroteo, Term: Egipcio, Faces: Ptolomeo - Bonatti.alm

		☾	♃	♄	☉	♅	♆	♁
ASC	♈02°N 11' 10"	3	11	3	1	3		
RASC	♈04°N 30' 58"		1		3		10	3
Luna	♃24°E 06' 03"	1	3			2	3	8
R Luna	♃04°E 01' 04"	3		9		3	5	1
Casa 5	♃04°E 24' 47"	3	2	3		7	1	5
R Casa 5	♃04°E 01' 04"	3		9		3	5	1
Júpiter	♃05°E 07' 19"		1		3		10	3
Marte	♄26°E 06' 25"	3		3	1	9		5
Total		16	18	27	8	27	34	26
		☾	♃	♄	☉	♅	♆	♁

21. Gestational Chart (Hermes/Bailey) (MAV9)

Chart based on the Trutina Hermetis method with the rules of H. M. Bailey.

Gestación (Hermes/Bailey)			
Hora Natal= 14:32:00			
-27.4	C:29/08/1961	21:43:49	R:14:43:49
0	C:25/09/1961	21:08:26	R:14:08:26
27.3	C:23/10/1961	21:42:42	R:14:42:42
Gestación (Hermes/Bailey)		Grafica Radix Rectificado	Cerrar

22. I Interaspects and Polarities (A. Polito) (MAV9)

Based on the work of Antonio Polito.

Allows the analysis of interaspects and polarities between charts.

Interaspectos y Polaridades (A. Polito)

Meridian Pro Gold 8.490 - www.catharsoftware.com

19/06/ 1952G-GMT21:32:00
N 34.03.00 / W 118.14.00
Los Angeles/USCA

27/12/ 1974G-GMT23:50:00
S 34.36.00 / W 058.25.00
Buenos Aires/RA

Tabla 1 - Interaspectos agrupados por su polaridad

Zona Roja, Interaspectos Yang de A con Yang de B
Zona Verde, Interaspectos Yin de A con Yin de B
Zona Amarilla, Interaspectos Yang de A con Yin de B
Zona Azul, Interaspectos Yin de A con Yang de B
Zona Gris, conexiones entre planetas de polaridad variable

	♂ 28 5	♂ 16 10	♂ 12 6	♂ 10 4R	♂ 21 8	♂ 3 9	♂ 11 0R	♂ 7 46	♂ 11 51	♂ 27 19	Total
♂ 5 31	7.8S							1.9A			2
♂ 12 5			3A	1.4S				4.3S	8S		4
♂ 12 39		3.5A	2S				1.7S	4.9S			5
♂ 16 12R		0A	3.8A		4.9S		5.7A				4
♂ 20 8	7.9A		7.7S						8.3S		3
♂ 18 21		2.2S			2.8A						2
♂ 10 17			2.1A	4A		7.1S		2.5S	1.6A		5
♂ 9 11				1.5A					2.7A		2
♂ 10 33		5.6A	1.9A		10.6A		4A	2.8S			5
♂ 1 44	3.6S					1.4A	9.3A			4.4S	4
Total	3	4	6	3	3	2	4	5	5	1	36

	Yang	Yin	Variable
Yang	7	6	2
Yin	6	3	3
Variable	3	5	1

Tabla 2 - Agrupación intermedia

Persona A	Persona B	Total
Yang	Yang	7
Yin	Yin	3
Yang	Yin	12
Yin	Yang	13
Variable	Variable	1

Tabla 3 - Agrupación final representativa de la relación

Los planetas de polaridad variable toman la polaridad inversa del planeta con el cual se conectan

23. Heptagrams (D. Neroman) (MAV9)

Based on the work of Dom Neroman.

Heptagramas (D. Neroman)
 01/12/ 1935G | HL:22:55:00 | DGMT:+05:00
 New York/USNY | N40.42.00/W074.00.00
 Tropical | Geocentric |(C)Koch

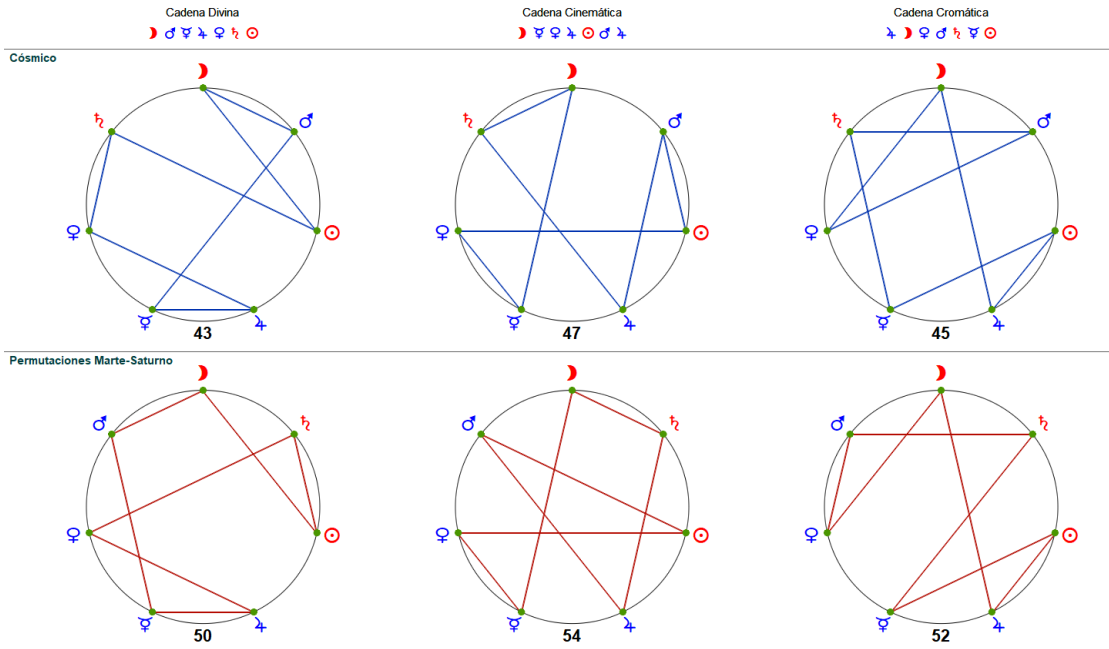

25. Dispositors Tool

Enabled through the context menu.

Radix-Dispositores Planetarios | Abdul, Paula

Meridian Pro Gold 9.001 - www.catharsoftware.com

Dispositores Modernos:

Sol en Géminis -> Mercurio
 Luna en Capricornio -> Saturno
 Mercurio en Géminis -> Mercurio
 Venus en Leo -> Sol
 Marte en Tauro -> Venus
 Júpiter en Piscis -> Neptuno
 Saturno en Acuario -> Urano
 Urano en Leo -> Sol
 Neptuno en Escorpio -> Plutón
 Plutón en Virgo -> Mercurio
 Nodo N Med en Leo -> Sol
 Nodo S Med en Acuario -> Urano
 Medio Cielo en Cáncer -> Luna
 Ascendente en Libra -> Venus
 P. Fortuna en Tauro -> Venus

Cadena de dispositivos:

Sol -> Mercurio -> Mercurio (CC)
 Luna -> Saturno -> Urano -> Sol -> Mercurio -> Mercurio (CC)
 Mercurio -> Mercurio (CC)
 Venus -> Sol -> Mercurio -> Mercurio (CC)
 Marte -> Venus -> Sol -> Mercurio -> Mercurio (CC)
 Júpiter -> Neptuno -> Plutón -> Mercurio -> Mercurio (CC)
 Saturno -> Urano -> Sol -> Mercurio -> Mercurio (CC)
 Urano -> Sol -> Mercurio -> Mercurio (CC)
 Neptuno -> Plutón -> Mercurio -> Mercurio (CC)
 Plutón -> Mercurio -> Mercurio (CC)
 Nodo N Med -> Sol -> Mercurio -> Mercurio (CC)
 Nodo S Med -> Urano -> Sol -> Mercurio -> Mercurio (CC)
 Medio Cielo -> Luna -> Saturno -> Urano -> Sol -> Mercurio -> Mercurio (CC)
 Ascendente -> Venus -> Sol -> Mercurio -> Mercurio (CC)
 P. Fortuna -> Venus -> Sol -> Mercurio -> Mercurio (CC)

Dispositores Finales: Mercurio

Árbol Dispositor Final

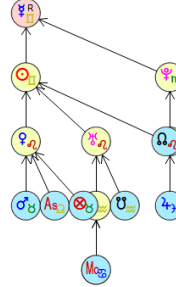

Dispositores Modernos:

Sol en Géminis -> Mercurio
 Luna en Capricornio -> Saturno
 Mercurio en Géminis -> Mercurio
 Venus en Leo -> Sol
 Marte en Tauro -> Venus
 Júpiter en Piscis -> Júpiter
 Saturno en Acuario -> Saturno
 Urano en Leo -> Sol
 Neptuno en Escorpio -> Marte
 Plutón en Virgo -> Mercurio
 Nodo N Med en Leo -> Sol
 Nodo S Med en Acuario -> Saturno
 Medio Cielo en Cáncer -> Luna
 Ascendente en Libra -> Venus
 P. Fortuna en Tauro -> Venus

Cadena de dispositivos:

Sol -> Mercurio -> Mercurio (CC)
 Luna -> Saturno -> Saturno (CC)
 Mercurio -> Mercurio (CC)
 Venus -> Sol -> Mercurio -> Mercurio (CC)
 Marte -> Venus -> Sol -> Mercurio -> Mercurio (CC)
 Júpiter -> Júpiter (CC)
 Saturno -> Saturno (CC)
 Urano -> Sol -> Mercurio -> Mercurio (CC)
 Neptuno -> Marte -> Venus -> Sol -> Mercurio -> Mercurio (CC)
 Plutón -> Mercurio -> Mercurio (CC)
 Nodo N Med -> Sol -> Mercurio -> Mercurio (CC)
 Nodo S Med -> Saturno -> Saturno (CC)
 Medio Cielo -> Luna -> Saturno -> Saturno (CC)
 Ascendente -> Venus -> Sol -> Mercurio -> Mercurio (CC)
 P. Fortuna -> Venus -> Sol -> Mercurio -> Mercurio (CC)

Dispositores Finales: Mercurio Saturno Júpiter

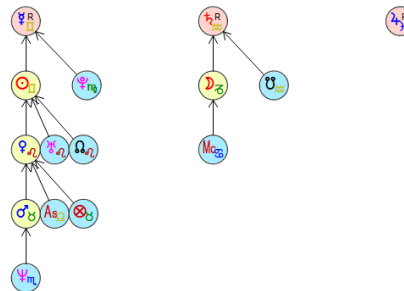

29. Astrological Assistant

Available in General Settings.

Helps less experienced users identify houses, signs, planets and aspects, and provides an interpretative framework.

Includes an editor to modify interpretation texts.

Editor Asistente Astrológico

Tabla: Signos

Orden: 1

Nombre: Aries

Descripción

Descripción general: Aries simboliza impulso vital, inicio y decisión. Representa la energía que se lanza a la acción con valentía y espontaneidad. Aries abre caminos, confronta obstáculos y aprende haciendo. Su esencia es fuego directo, inmediato y afirmativo.

Motivación básica: Busca independencia, movimiento y desafíos que despierten su fuerza interna. Necesita actuar sin demora y sentir que avanza por mérito propio.

Dinámica social: Interactúa con franqueza, dinamismo y entusiasmo. Prefiere vínculos directos, sin vueltas, donde la autenticidad sea la base del intercambio.

Desafío evolutivo: Evitar impulsividad, impaciencia o

Palabras Clave: acción, impulso, coraje, inicio, independencia, desafío

Botones: Modificar, Agregar, Cerrar

Radix | Abdul, Paula

19/06/ 1962G | HL 14.32.00 | DGMT+07:00:00
Los Angeles(USCA) | N34.03.00/W118.14.00
Tropical | Geocéntrico | (C)Placidus

Asistente Astrológico Inicial: Luna

La Luna representa el mundo emocional, las necesidades afectivas básicas y la forma de buscar seguridad, contacto y pertenencia.

En astrología tradicional simboliza el cuerpo emocional, la memoria, los hábitos, el instinto y la respuesta automática.

En la Psicología Astrológica Huber, expresa la voluntad buena, la necesidad de contacto y de sentirse querido, así como la sensibilidad para percibir el ambiente.

Es el indicador del aprendizaje emocional, del modo en que la persona conecta y reacciona frente a los demás.

Esotéricamente, la Luna es el vehículo de la forma y de la memoria ancestral.

Palabras Clave: emociones, protección, necesidades, hábitos, contacto, sensibilidad.

Uso Práctico: revela cómo la persona reacciona ante la vida, qué tipo de ambiente emocional necesita y cómo construye vínculos. En tránsitos y progresiones marca fluctuaciones emocionales, cambios de humor y temas familiares o de intimidad.

Planetas:
 ○ Sol
 ◐ Luna
 ☿ Mercurio
 ♀ Venus

30. Primary Directions Arc Tables with Contact Reports

Available in the Rectification Menu.

Includes different directional systems applicable to both mundane and zodiacal projections.

Arcos Direcciones Primarias | 19/06/1962 - 21:32:00 | Abdul, Paula [Horizontal B/P [Clave = Ptolomeo]]

Tipo	M/Z	P1	D/C	Aspecto	P2	Arco[Gra]	Pos. P1	Pos. P2	Fecha
D>N Hor	M	☉	D	♂	☉	0.0000	55.23.44	55.23.44	19/06/1962G
D>N Hor	M	♃	C	♂	♃	0.0000	354.43.18	354.43.18	19/06/1962G
D>N Hor	M	♆	D	♂	♆	0.0000	165.49.40	165.49.40	19/06/1962G
D>N Hor	M	♁	C	♂	♁	0.0000	198.33.17	198.33.17	19/06/1962G
D>N Hor	M	♂	D	♂	♂	0.0000	18.49.51	18.49.51	19/06/1962G
D>N Hor	M	♄	C	♂	♄	0.0000	330.58.53	330.58.53	19/06/1962G
D>N Hor	M	♁	C	♂	♁	0.0000	143.02.43	143.02.43	19/06/1962G
D>N Hor	M	♃	C	♂	♃	0.0000	292.49.57	292.49.57	19/06/1962G
D>N Hor	M	♁	C	♂	♁	0.0000	329.58.14	329.58.14	19/06/1962G
D>N Hor	M	♁	C	♂	♁	0.0000	198.40.34	198.40.34	19/06/1962G
D>N Hor	M	♁	D	♂	♁	0.0000	44.48.58	44.48.58	19/06/1962G
D>N Hor	M	♁	C	♂	♁	0.0000	149.58.14	149.58.14	19/06/1962G
D>N Hor	M	♆	C	♂	♃	0.0255	140.27.50	140.29.22	29/06/1962G
D>N Hor	M	♁	D	♂	♁	0.1158	198.40.14	198.33.17	01/08/1962G
D>N Hor	M	♁	C	♂	♁	0.1243	198.33.06	198.40.34	04/08/1962G
D>N Hor	M	♁	C	♂	♃	0.2563	126.43.56	126.59.19	21/09/1962G
D>N Hor	M	♁	D	♂	☉	0.3945	146.29.10	146.05.29	11/11/1962G
D>N Hor	M	♃	D	♂	♁	0.6063	330.34.37	329.58.14	27/01/1963G
D>N Hor	M	♁	C	♂	♃	0.6239	330.21.26	330.58.53	02/02/1963G

Reporte de Contactos Primarias | 19/06/1962 - 21:32:00 | Abdul, Paula [Placidus B/P [Clave = Ptolomeo]]

Fecha	Evento	Tipo	P1	D/C	Aspecto	P2	Orbe[Min]	Pos. P1	Pos. P2
24/04/2026G		D>N Pla Z	♁	C	♆	♁	10.3	12.11.25	76.02.13
29/12/2025G		D>N Pla Z	♁	C	♆	♁	8.7	93.41.58	157.13.43
04/01/2026G		D>N Pla Z	♁	C	♆	♁	7.7	93.40.57	157.13.43
20/02/2026G		D>N Pla Z	♁	C	♃	♃	0	247.05.11	310.45.39
20/02/2026G		D>N Pla Z	♁	C	♆	♁	0	292.51.36	112.23.25

32. Astrodynes Display according to Demetrio Santos

Enabled within the Harmonic Chart and Astrodynes editor.

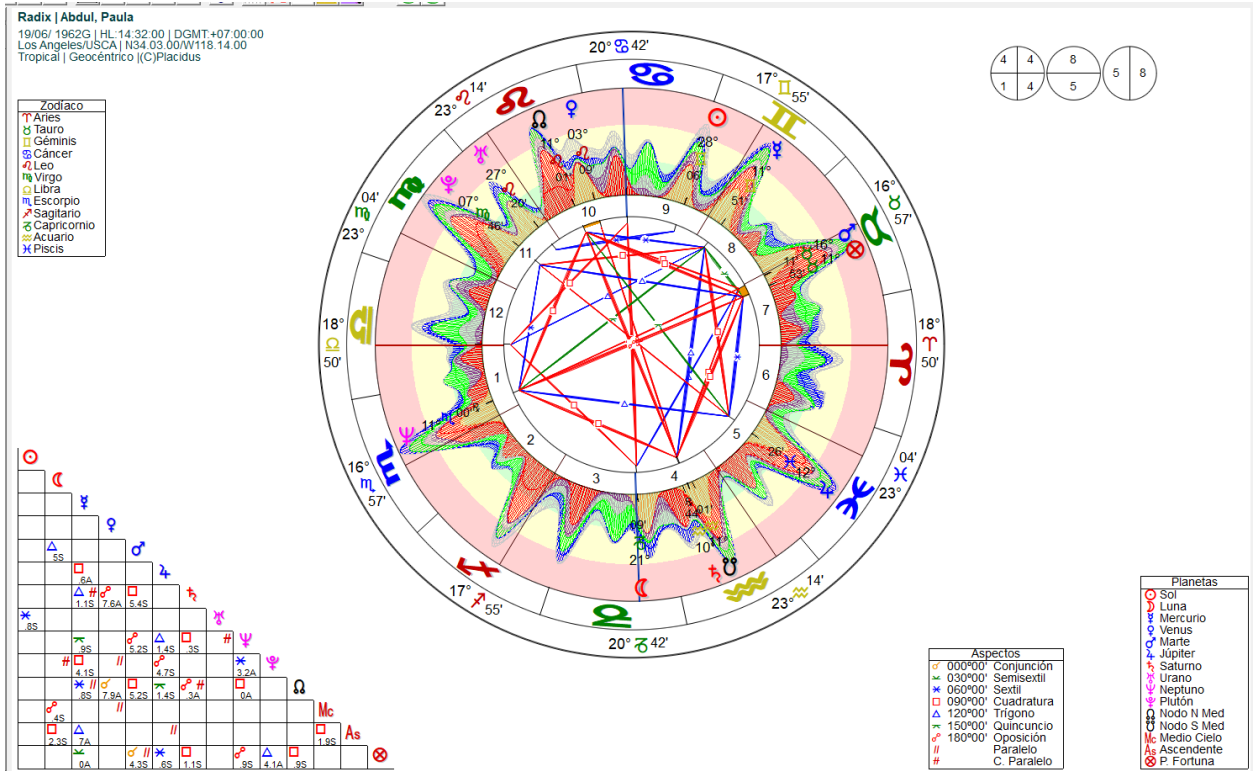

33. New Interpretation Text for Harmonic Flower

Includes updated interpretative text for the Harmonic Flower.

Radix-Carta Flor Armónica | Abdul, Paula
19/06/ 1962G | HL:14:32:00 | DGMT:+07:00:00
Los Angeles/USCA | N34.03.00/W118.14.00
Tropical | Geocéntrico | (C)Placidus

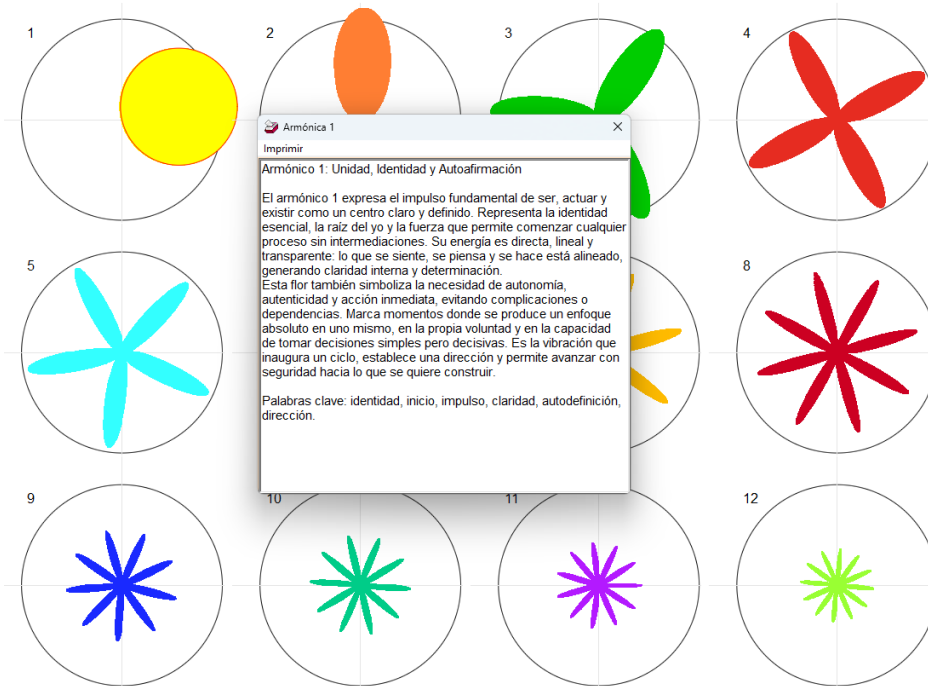

34. Multiple Composite Chart

Available in the Multiple Charts tab.
Allows selecting up to six clients simultaneously.

Individual Persona 1 | Sinistra Persona 2 | **Cartas Múltiples** | Carta Compuesta Múltiple

Amstrong, Louis
04/07/1900 [C] | DGMT +06:00
Hr. Local: 00:23:00
29 57 00 N / 090 04 00 W
New Orleans
USLA

Famosos

Buscar Amstrong, Louis

Abbado, Claudio
Abdul, Paula
Adenauer, Konrad
Alexander, Peter
Ali, Muhammad
Allen, Woody
Amstrong, Louis
Armstrong, Neil
Andress, Ursula
Aquino, Corazon
Arafat, Yasir

Selección Múltiple

Abbado, Claudio
Abdul, Paula
Adenauer, Konrad
Alexander, Peter
Ali, Muhammad
Allen, Woody

Elimina Registro | Limpia Toda la Lista

Radix
Rueda Doble
Rueda Triple
Rueda Cuadruple
Método Memoria Inconsciente
Carta Compuesta Múltiple

Abbado, Claudio
26/06/1933 | HL 02:00:00 | DGMT-01:00
009.12.00 E | N45.29.00 | E009.12.00

Abdul, Paula
18/06/1982 | HL 14:32:00 | DGMT+07:00:00
118.14.00 W | N34.03.00 | W118.14.00

Adenauer, Konrad
05/01/1876 | HL 10:30:00 | DGMT-00:27
006.59.00 E | N50.56.00 | E006.59.00

Alexander, Peter
30/06/1926 | HL 15:00:00 | DGMT-01:00
016.22.00 E | N48.13.00 | E016.22.00

Ali, Muhammad
17/01/1942 | HL 18:35:00 | DGMT+06:00
065.33.00 W | N31.47.00 | W065.33.00

Allen, Woody
01/12/1935 | HL 22:55:00 | DGMT+05:00
074.00.00 W | N40.42.00 | W074.00.00

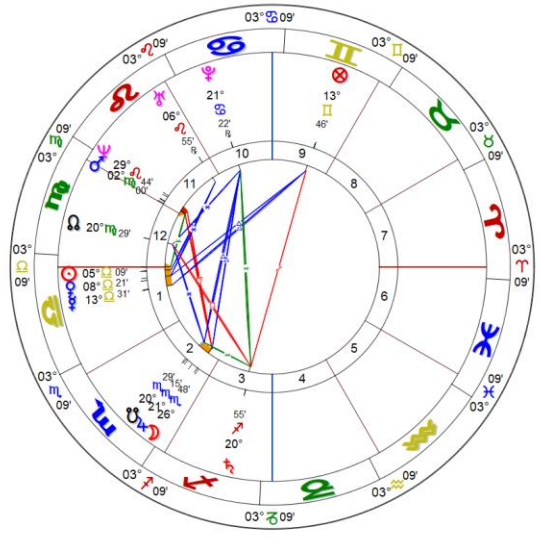

35. Gauquelin Sectors Tool

Available in the Natal Menu.

Sectores de Gauquelin | Abdul, Paula
 19/06/ 1962G | HL: 14:32:00 | DGMT:+07:00:00
 Los Angeles/USCA | N34.03.00/W118.14.00
 Tropical | Geocéntrico [(C)Placidus

Punto	Longitud	Dist (AU)	Sector	G+
☉	5° 8' 50"	1.0161	12	+
☽	26° 48' 9"	.0025	27	
☿	13° 31' 18"	.6376	13	
♀	8° 20' 48"	1.2519	8	
♂	1° 59' 35"	1.9947	16	
♃	21° 15' 5"	4.6402	23	
♄	20° 55' 21"	9.1934	26	
♅	6° 55' 20R	18.8281	6	
♆	29° 44' 1"	29.6268	34	
♇	21° 21' 33R	33.5827	5	
♁	20° 29' 1R	.0025	8	
♂	20° 29' 1R	.0025	26	
♁	13° 45' 38"	0	22	

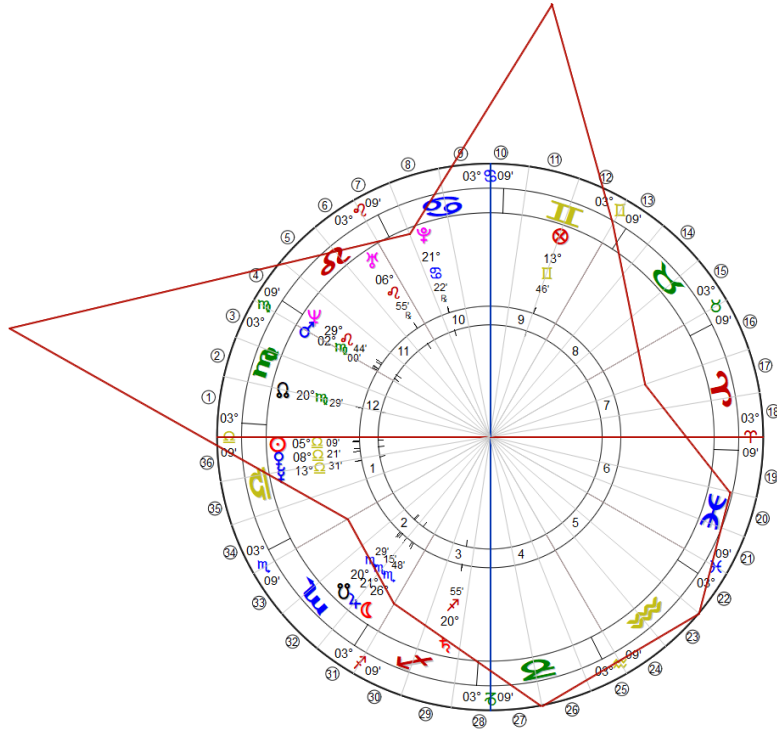

36. Individual Planetary Cycles Tool

Available in the Transits Menu.

Allows identifying the cycle of a planet in relation to its natal position.

Ciclos Planetarios Individuales Sol | Abdul, Paula

2°13'42" X

20/02/2026

Fecha

Día
+ 1 | - 1

Semana
+ 1 | - 1

Mes
+ 1 | - 1

Año
+ 1 | - 1

Otra

Hora Natal

Segundo
+ 1 | - 1

Minuto
+ 1 | - 1

19/06/1962
GMT 21:32:00

Otra

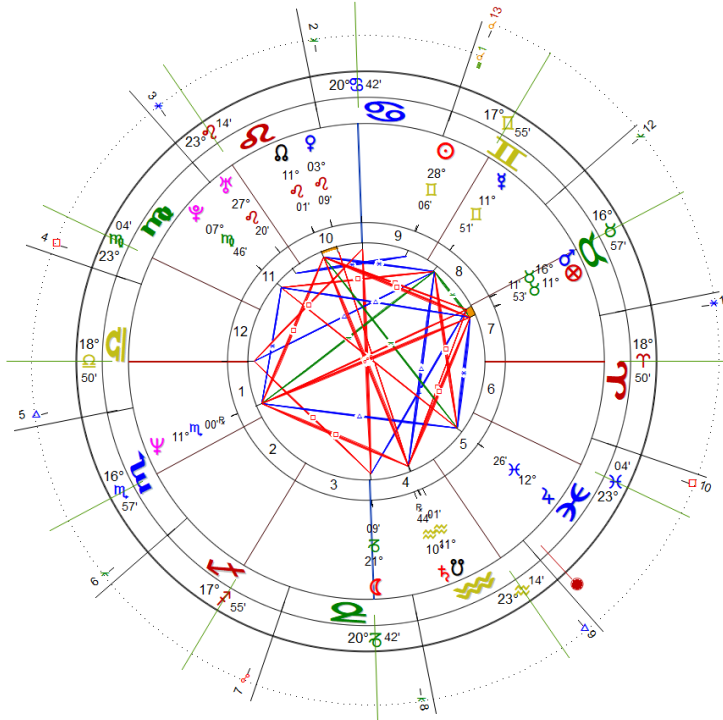

1	♂	18/06/2025	28°05'	♈
2	♂	20/07/2025	28°05'	♈
3	♂	20/08/2025	28°05'	♈
4	♂	20/09/2025	28°05'	♈
5	♂	20/10/2025	28°05'	♈
6	♂	19/11/2025	28°05'	♈
7	♂	19/12/2025	28°05'	♈
8	♂	17/01/2026	28°05'	♈
9	♂	16/02/2026	28°05'	♈
10	♂	18/03/2026	28°05'	♈
11	♂	17/04/2026	28°05'	♈
12	♂	18/05/2026	28°05'	♈
13	♂	18/06/2026	28°05'	♈

37. Lunations and Eclipses Charts Tool (Melocation Module)

Generates charts for Lunations and Eclipses.
Requires the Geolocation module.

Luna Nueva[20/02/2026] [M] | Abdul, Paula
22/08/ 2025G - HL 22.08-44-DGMT+07:00:00 -Los Angeles/
[19/06/ 1962G- HL 14.32:00-Los Angeles/USCA]
Topocéntrico
Pós. En Long Ob. Y Decl Ob.
CABA orb, 100%

Modos	
Cardinal	<div style="width: 100%; height: 10px; background-color: red;"></div>
Fijo	<div style="width: 100%; height: 10px; background-color: blue;"></div>
Mutable	<div style="width: 100%; height: 10px; background-color: green;"></div>

Elementos	
Fuego	<div style="width: 100%; height: 10px; background-color: red;"></div>
Tierra	<div style="width: 100%; height: 10px; background-color: green;"></div>
Aire	<div style="width: 100%; height: 10px; background-color: yellow;"></div>
Agua	<div style="width: 100%; height: 10px; background-color: blue;"></div>

Navegación

OTRA

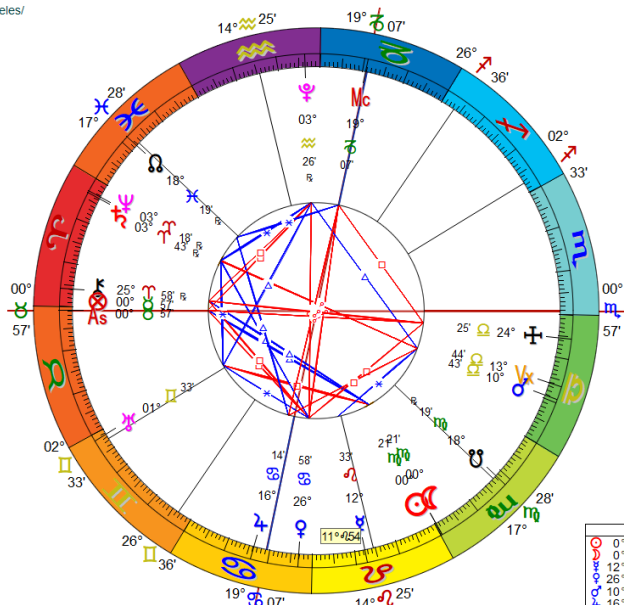
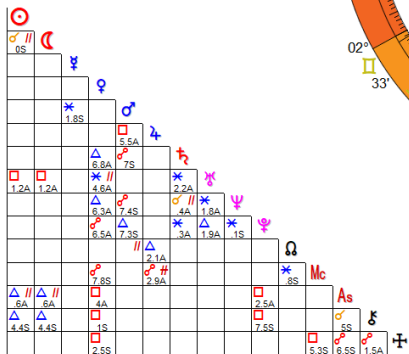

Antiscio			
♂	29° 39' 19"	♂	C12
♂	29° 39' 19"	♂	C12
♂	17° 27' 18"	♂	C 1
♂	3° 02' 16"	♂	C 2
♂	19° 17' 00"	♂	C12
♂	13° 45' 52"	♂	C 2
♂	26° 16' 54R	♂	C 6
♂	28° 27' 15"	♂	C 4
♂	26° 42' 10R	♂	C 6
♂	26° 33' 58R	♂	C 7
♂	11° 40' 33R	♂	C 6
♂	11° 40' 33R	♂	C12
♂	10° 52' 33"	♂	C 8
♂	29° 02' 44"	♂	C 5
♂	29° 02' 44"	♂	C 5
♂	16° 16' 08"	♂	C11
♂	4° 02' 16R	♂	C 5
♂	5° 34' 35"	♂	C11

Cuspides Casas			
1	0° 57' 16"	♂	11° 48' 20"
2	2° 33' 26"	♂	20° 40' 16"
3	26° 36' 3"	♂	23° 23' 41"
4	19° 7' 27"	♂	22° 04' 28"
5	14° 24' 36"	♂	16° 30' 28"
6	17° 27' 34"	♂	04° 57' 17"
7	0° 57' 16"	♂	-11° 48' 20"
8	2° 33' 26"	♂	-20° 40' 16"
9	26° 36' 3"	♂	-23° 23' 41"
10	19° 7' 27"	♂	-22° 04' 28"
11	14° 24' 36"	♂	-16° 30' 28"
12	17° 27' 34"	♂	-04° 57' 17"

Longitud		
♂	0° 20' 41"	♂ C 5
♂	0° 20' 41"	♂ C 5
♂	12° 32' 42"	♂ C 4
♂	26° 57' 44"	♂ C 4
♂	10° 43' 00"	♂ C 6
♂	16° 14' 08"	♂ C 3
♂	3° 43' 08R	♂ C12
♂	1° 32' 45"	♂ C 1
♂	3° 17' 50R	♂ C12
♂	3° 26' 02R	♂ C10
♂	18° 19' 27R	♂ C12
♂	18° 19' 27R	♂ C 6
♂	19° 07' 27"	♂ C10
♂	0° 57' 16"	♂ C 1
♂	0° 57' 16"	♂ C 1
♂	13° 43' 52"	♂ C 6
♂	25° 57' 44R	♂ C12
♂	24° 25' 25"	♂ C 6

Declinación	
♂	11° 21' 01"
♂	11° 21' 01"
♂	17° 02' 27"
♂	20° 45' 53"
♂	-04° 14' 30"
♂	-22° 27' 06"
♂	01° 28' 41"
♂	20° 28' 11"
♂	01° 18' 39"
♂	19° 23' 12"
♂	-04° 37' 02"
♂	-04° 37' 02"
♂	-22° 04' 28"
♂	11° 48' 20"
♂	11° 48' 20"
♂	-05° 25' 04"
♂	10° 01' 42"
♂	-09° 27' 59"

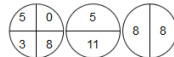

38. Birthday Alert Tool

Allows receiving notifications of clients' birthdays within selected tables and defined time ranges.

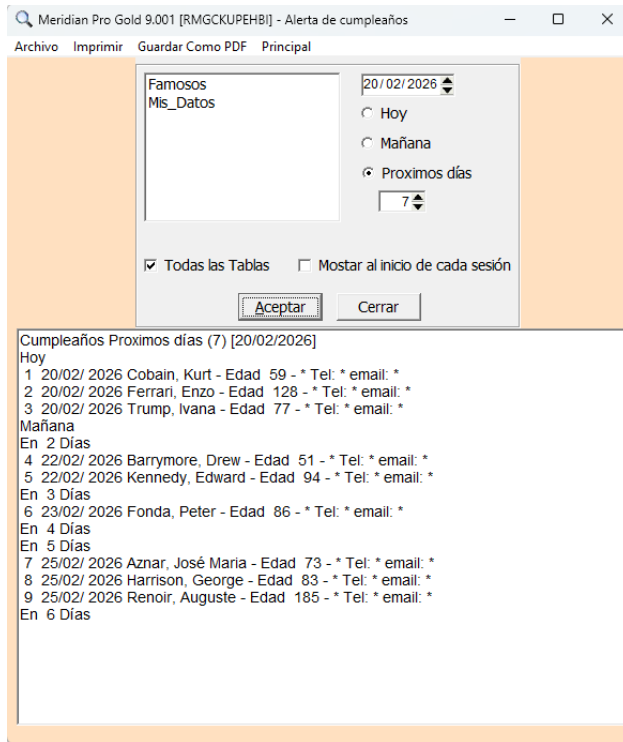

39. Angel of the Day Tool

Provides daily angelic correspondences.

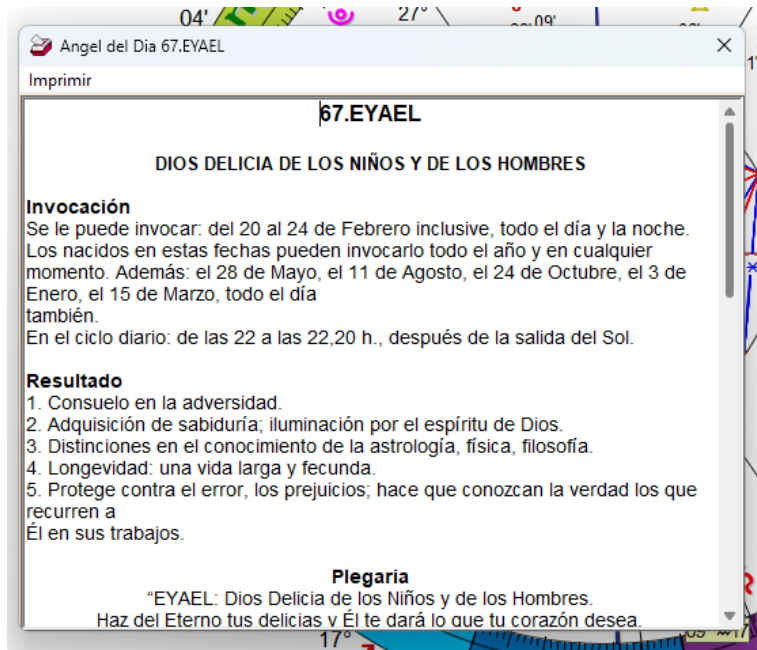

Angel del Dia 67.EYAEL

Imprimir

67.EYAEL

DIOS DELICIA DE LOS NIÑOS Y DE LOS HOMBRES

Invocación
Se le puede invocar: del 20 al 24 de Febrero inclusive, todo el día y la noche. Los nacidos en estas fechas pueden invocarlo todo el año y en cualquier momento. Además: el 28 de Mayo, el 11 de Agosto, el 24 de Octubre, el 3 de Enero, el 15 de Marzo, todo el día también.
En el ciclo diario: de las 22 a las 22,20 h., después de la salida del Sol.

Resultado

1. Consuelo en la adversidad.
2. Adquisición de sabiduría; iluminación por el espíritu de Dios.
3. Distinciones en el conocimiento de la astrología, física, filosofía.
4. Longevidad: una vida larga y fecunda.
5. Protege contra el error, los prejuicios; hace que conozcan la verdad los que recurren a Él en sus trabajos.

Plegaria
"EYAEL: Dios Delicia de los Niños y de los Hombres.
Haz del Eterno tus delicias y Él te dará lo que tu corazón desea.

40. Improvements in Fixed Stars Editor

Enhancements in usability and functionality of the Fixed Stars editor.

Editor de Estrellas Fijas

Mostrar Grupo: 1-21 Estrellas Brillantes

Todo el Catálogo: Sirius

Estrella Usuario-EU: Sirius

Establecer como Estrella Usuario

ID	Nombre	Nombre
301	aCMa	Sirius

Constelación: Canis Major

Fecha Ref. [ICRS]

Naturaleza: 54 4♂

Grupo: 123475

Posición - Aparentes: 20/02/2026

Sirius

Longitud: 14°27'11"

Latitud: -39°36'20"

Asc. Recta: 101°35'04"

Asc. Recta [hh.mm.ss]: 06:46:20

Declinación: -16°44'45"

V. Rad	An. Para.	Magnitud	Asc. Recta [hh.mm.ss]	Declinación	V.AR part. [s/S]	V.Decl part. [s arc/S]
-7.6	.37921	-1.46	06:45:08.9173	-16°42'58.017	-3.64034	-122.314

Palabras Clave: iluminación, fama, protección, éxito

Información Parcial: Brillo supremo y conciencia despierta. Éxito que trasciende generaciones.

Info. Completa

Etimología y Contexto
 Su nombre proviene del griego Seirios, que significa 'La Resplandeciente' o 'La Ardiente'. Es la estrella más brillante de todo el cielo nocturno y la luminaria principal de Canis Major. Ha sido venerada por todas las civilizaciones antiguas (como Sothis en Egipto). Representa la iluminación suprema, el despertar de la conciencia y el éxito que quema cualquier obstáculo. Simboliza el 'Sol de Soles'.

Perfil Astronómico
 Sirius es un sistema binario compuesto por una estrella blanca de la secuencia principal y una densa enana blanca.

Eliminar Modificar Agregar Restaurar Catálogo Original Cerrar

41. Improved Magnifier Quality

Enhancements in the quality and precision of the integrated magnifier.

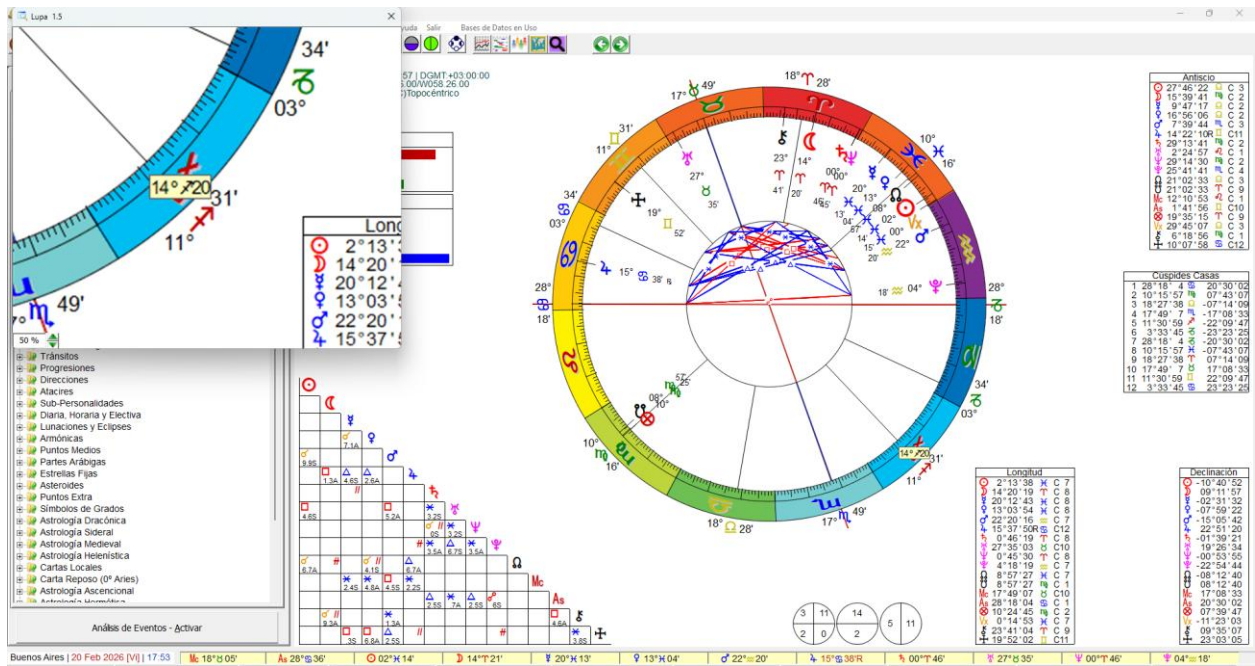

43. Sign Comparison Tool with Transit Wheel

Allows comparison between signs with an integrated transit wheel.

Comparación Signos con Tránsitos

(Int)Abbado, Claudio
 26/06/1933G-GMT: 1:00:00
 N 45.28.00 / E 009.11.59
 Milano (mian)/I

(Ext)Alexander, Peter
 30/06/1926G-GMT:14:00:00
 N 48.13.00 / E 016.19.59
 Wien (vienna)/A

Signo	Asc	Dec	Asc	Dec
♈	3°58'4	♈	24°19'56	
♉	7°0'15	♉	4°33'52'36	
♊	28°44'4	♊	4°21'39'51	
♋	21°25'21	♋	3°22'56'26	
♌	24°18'0	♌	5°2'43'50	
♍	16°20'47R	♍	5°5'30'05	
♎	15°40'29	♎	10°-16'10'48	
♏	26°50'50	♏	12°10'22'33	
♐	7°47'1	♐	5°8'40'06	
♑	22°28'4	♑	3°21'35'28	
♒	29°52'30	♒	11°-11'34'21	
♓	29°52'30	♓	5°11'27'31	
♈	25°54'56	♈	10°-20'57'46	
♉	19°2'43	♉	17°28'54	
♊	16°0'32	♊	6°17'52	
♋	21°16'20	♋	6°-8'17'50	
♌	21°18'3	♌	1°20'29'01	
♍	10°25'12	♍	6°-4'07'32	

Casas
 Topocéntrico

Casa	Asc	Dec
1	19°2'43	17°28'54
2	15°35'10	22°39'32
3	5°47'26	23°18'42
4	25°54'56	20°57'46
5	20°24'30	14°41'05
6	25°46'18	01°17'01
7	19°2'43	-17°28'54
8	15°35'10	-22°39'32
9	5°47'26	-23°18'42
10	25°54'56	-20°57'46
11	20°24'30	-14°41'05
12	26°46'18	-01°17'01

20/02/2026 | GMT: 01:00:00

Fecha
 Segundo
 +1 -1
 Hora
 +1 -1
 Día
 +1 -1
 Semana
 +1 -1
 Mes
 +1 -1
 Año
 +1 -1
 Otra

Casas
 Topocéntrico

Casa	Asc	Dec
1	9°13'50	-14°40'33
2	8°37'30	-21°44'26
3	14°1'27	-22°42'00
4	21°50'22	-14°13'37
5	24°34'15	-02°09'24
6	19°53'20	07°46'37
7	9°37'50	14°40'33
8	8°37'30	21°44'26
9	14°1'27	22°42'00
10	21°50'22	14°13'37
11	24°34'15	02°09'24
12	19°53'20	-07°46'37

Tránsitos

Signo	Asc	Dec	Casas
♈	1°23'34	♈	3 -10°58'44
♉	2°41'22	♉	4 2°28'54
♊	19°28'3	♊	3 -3°00'42
♋	12°1'49	♋	3 -8°23'26 1 3°26'37
♌	21°41'9	♌	3 -15°18'21 2 6°39'2
♍	15°40'50R	♍	8 22°50'56 3 16°9'19
♎	0°40'37	♎	4 -1°41'40 4 23°40'1
♏	27°34'20	♏	6 19°26'24 5 22°51'41
♐	0°43'49	♐	4 -0°54'36 15°9'35
♑	4°16'52	♑	2 -22°54'58 7 3°26'37
♒	9°31'17R	♒	3 -7°59'57 8 6°39'2
♓	9°31'17R	♓	9 7°59'57 9 16°9'19
♈	23°40'1	♈	10 2°30'53 10 23°40'1
♉	3°26'37	♉	1 -20°50'32 11 22°51'41
♊	2°8'49	♊	11 -12°13'08 12 15°9'35

44. AAF Data Import Option (Astro.com)

Available in File → Import Natal Data.

Data must be prepared and downloaded from Astro.com before importing.

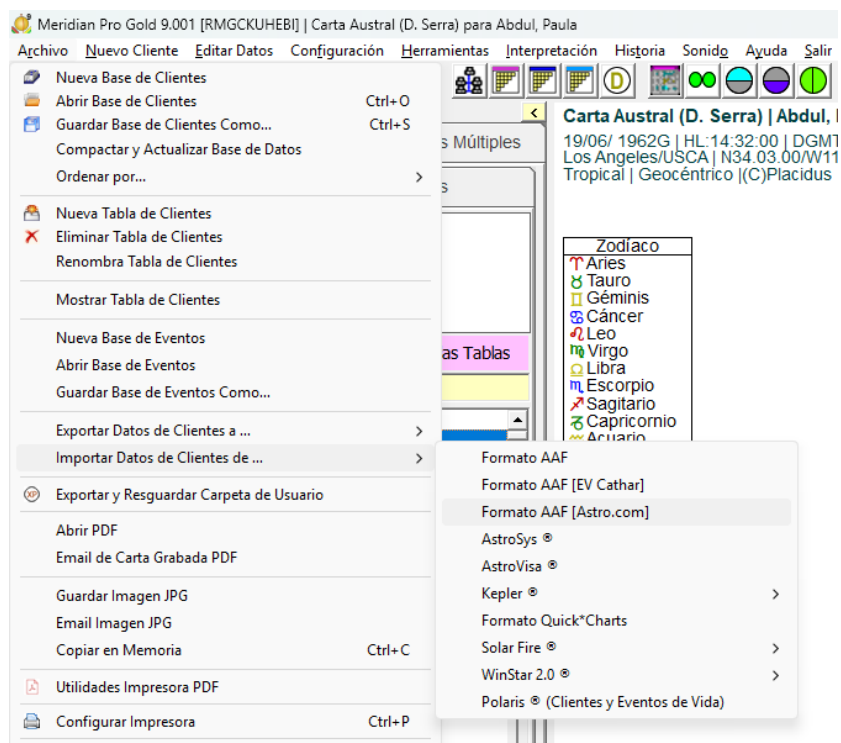

45. Kabbalah Chart – Lej Lejá Method by Eugenia Pinery (Kabbalah Module)

Available within the Kabbalah module.

Carta Método Lej Lejá (E. Pinery) | Abbado, Claudio
 26/06/1933G | HL_02:00:00 | DGMT-01:00:00
 Milano (milan) | N45.28.00|E009.11.59
 Tropical | Geocéntrico | (C)Topocéntrico

Meridian Pro Gold 9.001 - www.catharsoftware.com

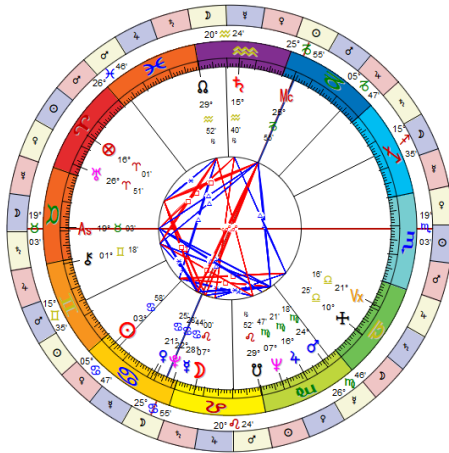

Día: Luna
 Hora: Marte

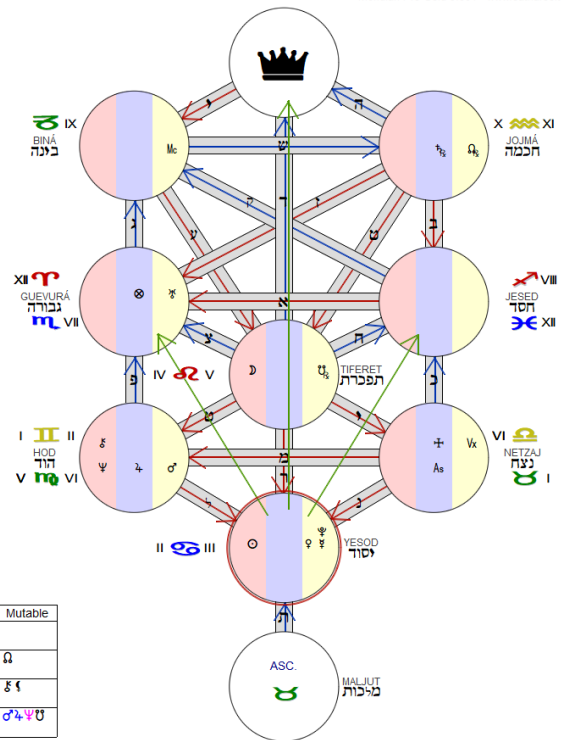

☉	3°58'04"	♌	2	Yesod	יְסוּד
☽	7°00'15"	♌	4	Tiferet	תִּפְרֵת
♃	28°44'04"	♌	4	Yesod	יְסוּד
♅	21°25'21"	♌	3	Yesod	יְסוּד
♄	24°18'00"	♌	5	Hod	הוֹד
♁	16°20'47"	♌	5	Hod	הוֹד
♂	15°40'28R	♌	C10	Jojmá	הַכְּמָה
♆	28°50'50"	♌	C12	Guevurá	גְּבוּרָה
♁	7°47'01"	♌	5	Hod	הוֹד
♃	22°28'04"	♌	3	Yesod	יְסוּד
♅	29°52'30R	♌	C11	Jojmá	הַכְּמָה
♄	29°52'30R	♌	C5	Tiferet	תִּפְרֵת
♁	25°54'56"	♌	C10	Biná	בִּינָה
♂	19°02'43"	♌	C1	Netzaj	נְצַחַת
♆	16°00'32"	♌	C12	Guevurá	גְּבוּרָה
♁	21°16'20"	♌	C6	Netzaj	נְצַחַת

	Cardinal	Fijo	Mutable
Fuego	♂	♃	
Agua	♁ ♃ ♁		♌
Aire		♂	♄ ♁
Tierra	♌	♁	♂ ♁ ♁

Carta Método Lej Lejá (E. Pinery) | Abbado, Claudio
 26/06/1933G | HL_02:00:00 | DGMT-01:00:00
 Milano (milan) | N45.28.00|E009.11.59
 Tropical | Geocéntrico | (C)Topocéntrico

Meridian Pro Gold 9.001 - www.catharsoftware.com

Distribución por Columna									
RECIBIR Severidad	COMPARTIR Equilibrio	DAR Misericordia							
11	14	7							
Distribución por Triadas									
Mental	Emocional	Social							
3	6	23							
Distribución por Sefirot									
Yesod	Hod	Netzaj	Tiferet	Guevurá	Jesed	Biná	Jojmá		
10	9	4	4	1	1	1	2		
Distribución por Decanatos									
Yod Individual	Hei Vincular	Vav Social							
12	9	11							
Distribución por Decatemorias									
Majlut	Yesod	Hod	Netzaj	Tiferet	Guevurá	Jesed	Biná	Jojmá	Keter
0	6	1	4	2	3	4	6	2	4

Día: Luna
 Hora: Marte

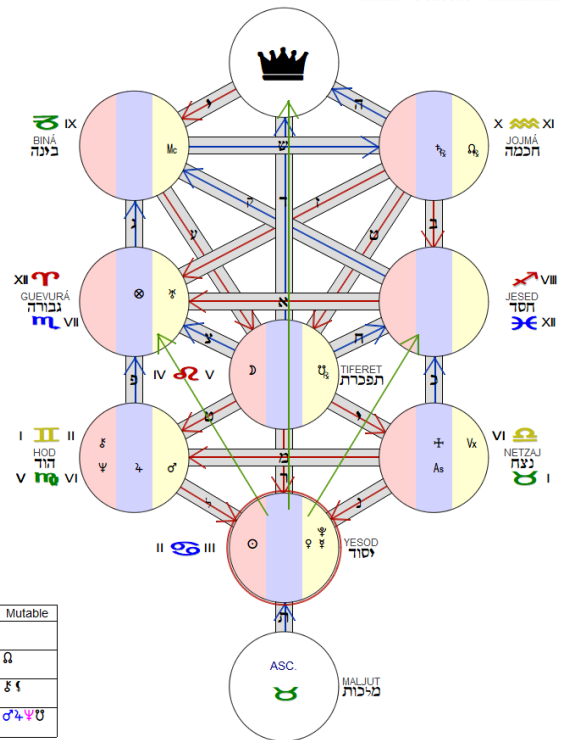

TETRAGRAMA		
Características por Elemento		
Elemento	Valores	Orden
Fuego	5	Vav / 3
Agua	11	Hei / 2
Aire	4	2Hei / 4
Tierra	12	Yod / 1
Características por Cruz		Permutaciones Mes=Jeshvan Signo=Escorpio
Cruz	Valores	
Cardinal	12	
Fijo	10	
Mutable	10	

	Cardinal	Fijo	Mutable
Fuego	♂	♃	
Agua	♁ ♃ ♁		♌
Aire		♂	♄ ♁
Tierra	♌	♁	♂ ♁ ♁

46. REXAS and REX-Zero (D. Santos)

Based on the work of Demetrio Santos and disseminated by José Luis Pascual Blánquez.

Rexas y Rex-Cero (D. Santos) | Abbado, Claudio

26/06/ 1933G | HL:02:00:00 | DGMT-01:00:00
 Milano (milan) | N45.28.00/E009.11.59
 Tropical | Geocéntrico | (C)Placidus

Grado	W	Z1	Z2	Z3	Z4	Z5	Z6	Z7	Z8	Z9	Z10
1	3.9909	0.0000	0.0000	1.6092	0.5298	0.0000	0.7772	1.0747	0.0000	0.0000	0.0000
2	5.1447	2.3258	0.0000	0.0000	0.7161	0.0000	0.7644	0.8186	0.0000	0.0000	0.5198
3	5.3330	3.1198	0.0000	0.0000	0.8762	0.0000	0.6239	0.0000	0.0000	0.0000	0.7130
4	5.9656	3.7259	0.0000	0.0000	0.8880	0.0000	0.4624	0.0000	0.0000	0.0000	0.8893
5	7.0081	3.6487	1.7006	0.0000	0.7375	0.0000	0.0000	0.0000	0.0000	0.0000	0.9214
6	6.4815	2.9572	2.1988	0.0000	0.5448	0.0000	0.0000	0.0000	0.0000	0.0000	0.7808
7	5.6370	2.1678	2.4349	0.0000	0.0000	0.4484	0.0000	0.0000	0.0000	0.0000	0.5859
8	3.2791	0.0000	2.1880	0.4995	0.0000	0.5916	0.0000	0.0000	0.0000	0.0000	0.0000
9	3.0540	0.0000	1.6803	0.6845	0.0000	0.6893	0.0000	0.0000	0.0000	0.0000	0.0000
10	4.2155	1.4758	1.2099	0.8736	0.0000	0.6562	0.0000	0.0000	0.0000	0.0000	0.0000
11	3.3920	1.9257	0.0000	0.9457	0.0000	0.5206	0.0000	0.0000	0.0000	0.0000	0.0000
12	4.5662	2.1692	0.0000	0.8312	0.0000	0.3772	0.0000	1.1886	0.0000	0.0000	0.0000
13	4.2526	1.9841	0.0000	0.6306	0.0000	0.0000	0.0000	1.6379	0.0000	0.0000	0.0000
14	3.6115	1.5391	0.0000	0.0000	0.0000	0.0000	0.0000	2.0723	0.0000	0.0000	0.0000
15	3.3069	1.1116	0.0000	0.0000	0.0000	0.0000	0.0000	2.1953	0.0000	0.0000	0.0000
16	1.8946	0.0000	0.0000	0.0000	0.0000	0.0000	0.0000	1.8946	0.0000	0.0000	0.0000
17	2.0661	0.0000	0.6331	0.0000	0.0000	0.0000	0.0000	1.4329	0.0000	0.0000	0.0000
18	0.8239	0.0000	0.8239	0.0000	0.0000	0.0000	0.0000	0.0000	0.0000	0.0000	0.0000
19	2.4216	0.0000	0.9252	0.0000	1.4964	0.0000	0.0000	0.0000	0.0000	0.0000	0.0000
20	4.7279	0.0000	0.8435	0.0000	2.0419	0.0000	0.0000	0.0000	0.0000	0.0000	1.8425
21	6.5254	0.0000	0.6525	0.0000	2.5874	0.0000	0.0000	0.0000	0.0000	0.7357	2.5498
22	7.5377	0.0000	0.4702	0.0000	2.7737	0.0000	0.0000	0.0000	0.0000	1.0042	3.2896
23	7.2608	0.0000	0.0000	0.0000	2.4154	0.0000	0.0000	0.0000	1.2412	3.6041	
24	11.1402	0.0000	0.0000	0.0000	1.8210	0.0000	0.0000	4.8428	1.2706	3.2058	
25	10.2078	0.0000	0.0000	0.0000	0.0000	0.0000	0.0000	6.6839	1.0660	2.4580	
26	9.3430	0.0000	0.0000	0.0000	0.0000	0.0000	0.0000	8.5477	0.7953	0.0000	
27	12.1074	0.0000	0.0000	1.9691	0.9108	0.0000	0.0000	9.2276	0.0000	0.0000	
28	13.1396	0.0000	0.0000	2.5808	1.2240	0.0000	0.0000	8.0954	0.0000	1.2394	
29	12.2816	0.0000	0.0000	2.9444	1.4837	0.0000	0.0000	6.1631	0.0000	1.6904	
30	7.0689	0.0000	0.0000	2.7319	1.4858	0.0000	0.7629	0.0000	0.0000	0.0000	2.0883
31	6.5043	0.0000	0.0000	2.1343	1.2220	0.0000	1.0105	0.0000	0.0000	0.0000	2.1374
32	6.5321	1.1392	0.0000	1.5409	0.8975	0.0000	1.1620	0.0000	0.0000	0.0000	1.7925
33	3.9815	1.5592	0.0000	0.0000	0.0000	0.0000	1.0859	0.0000	0.0000	0.0000	1.3364
34	3.7221	1.9862	0.0000	0.8796	0.0000	0.0000	0.8563	0.0000	0.0000	0.0000	0.0000
35	8.3556	2.1452	1.8035	1.2005	0.0000	0.0000	0.6255	1.2364	0.0000	1.3445	0.0000
36	9.3375	1.8815	2.3998	1.5208	0.0000	0.0000	0.0000	1.6810	0.0000	1.8543	0.0000
37	10.3202	1.4254	2.8308	1.6288	0.0000	0.0000	0.0000	2.0600	0.0000	2.3752	0.0000
38	9.4292	0.0000	2.7327	1.4174	0.0000	0.6206	0.0000	2.0845	0.0000	2.5740	0.0000
39	8.0804	0.0000	2.1901	1.0688	0.0000	0.8226	0.0000	1.7329	0.0000	2.2660	0.0000
40	5.5510	0.0000	1.5946	0.0000	0.0000	0.9422	0.0000	1.2872	0.0000	1.7269	0.0000
41	0.8764	0.0000	0.0000	0.0000	0.0000	0.8764	0.0000	0.0000	0.0000	0.0000	0.0000

Grado	W	Z1	Z2	Z3	Z4	Z5	Z6	Z7	Z8	Z9	Z10
1	3.3373	0.0000	2.8853	0.0000	0.0000	0.0000	0.0000	0.0000	0.0000	0.0000	0.4520
2	7.5910	1.3886	2.5683	0.0000	2.7134	0.0000	0.0000	0.0000	0.0000	0.3439	0.5769
3	11.3569	1.9080	1.9701	0.0000	3.7366	0.0000	0.0000	0.0000	0.0000	0.4631	0.6246
4	11.8891	2.4083	0.0000	0.0000	4.7418	0.0000	0.0000	0.0000	0.0000	0.5607	0.5493
5	13.1669	2.5461	0.0000	0.0000	5.0536	0.0000	0.0000	0.0000	0.0000	0.5597	0.4170
6	11.9317	2.1931	0.0000	0.0000	4.3840	0.0000	0.0000	0.0000	0.0000	0.4598	0.0000
7	9.8949	1.6553	0.0000	0.0000	3.3215	0.0000	0.0000	0.0000	0.0000	0.3385	0.3356
8	6.3651	0.0000	0.0000	0.0000	0.0000	0.0000	0.0000	0.0000	0.0000	0.0000	0.4351
9	0.8973	0.0000	0.0000	0.0000	0.0000	0.0000	0.0000	0.4126	0.0000	0.0000	0.4847
10	4.2619	0.0000	0.0000	3.2700	0.0000	0.0000	0.5336	0.0000	0.0000	0.4383	0.0000
11	5.3011	0.0000	0.0000	4.2986	0.0000	0.0000	0.6647	0.0000	0.0000	0.3378	0.0000
12	5.7772	0.0000	0.0000	4.8776	0.0000	0.0000	0.6561	0.0000	0.0000	0.2436	0.0000
13	5.0290	0.0000	0.0000	4.4946	0.0000	0.0000	0.5345	0.0000	0.0000	0.0000	0.0000
14	3.9063	0.0000	0.0000	3.5142	0.0000	0.0000	0.3921	0.0000	0.0000	0.0000	0.0000
15	2.8639	0.0000	0.0000	2.5593	0.0000	0.0000	0.3046	0.0000	0.0000	0.0000	0.0000
16	0.4122	0.0000	0.0000	0.0000	0.0000	0.0000	0.4122	0.0000	0.0000	0.0000	0.0000
17	0.9855	0.0000	0.0000	0.0000	0.0000	0.4796	0.5059	0.0000	0.0000	0.0000	0.0000
18	6.3358	0.0000	3.1085	0.0000	0.0000	0.6475	0.5147	2.0651	0.0000	0.0000	0.0000
19	8.1746	0.0000	4.1561	0.0000	0.0000	0.7712	0.4291	2.8182	0.0000	0.0000	0.0000
20	11.5353	0.0000	4.8836	0.0000	2.0421	0.7535	0.3177	3.5384	0.0000	0.0000	0.0000
21	13.4374	0.0000	4.6802	0.0000	2.7138	6.0933	0.0000	3.7260	0.0000	0.0000	1.7082
22	13.6905	0.0000	3.7481	0.0000	3.1452	4.4457	0.0000	3.1953	0.0000	0.8969	2.2593
23	12.2515	0.0000	2.7500	0.0000	2.9661	3.3567	0.0000	2.3973	0.0000	1.1640	2.6175
24	6.6016	0.0000	0.0000	0.0000	2.3521	4.4814	0.0000	0.0000	0.0000	1.2977	2.4704
25	5.4357	0.0000	0.0000	0.0000	1.7211	5.5865	0.0000	0.0000	0.0000	1.1744	1.9536
26	4.8679	1.9515	0.0000	0.0000	0.0000	5.5907	0.0000	0.0000	0.0000	0.9059	1.4198
27	5.6131	2.6972	0.0000	1.7738	0.0000	4.4884	0.0000	0.0000	0.0000	0.6536	0.0000
28	6.2366	3.4641	0.0000	2.4121	0.0000	3.3604	0.0000	0.0000	0.0000	0.0000	0.0000
29	8.2154	3.7661	0.0000	2.9482	0.0000	0.0000	0.0000	0.0000	0.0000	1.5010	0.0000
30	9.1568	3.3264	0.0000	2.9707	0.0000	0.0000	0.8083	0.0000	0.0000	2.0515	0.0000
31	8.6850	2.5427	0.0000	2.4636	0.0000	0.0000	1.0948	0.0000	0.0000	2.5840	0.0000
32	5.9096	0.0000	0.0000	1.8313	0.0000	0.0000	1.3446	0.0000	0.0000	2.7337	0.0000
33	3.7230	0.0000	0.0000	0.0000	0.0000	0.0000	1.3690	0.0000	0.0000	2.3540	0.0000
34	2.9120	0.0000	0.0000	0.0000	0.0000	0.0000	1.1419	0.0000	0.0000	1.7701	0.0000
35	2.5369	0.0000	1.6908	0.0000	0.0000	0.0000	0.8461	0.0000	0.0000	0.0000	0.0000
36	2.3230	0.0000	2.3230	0.0000	0.0000	0.0000	0.0000	0.0000	0.0000	0.0000	0.0000
37	2.9198	0.0000	2.9198	0.0000	0.0000	0.0000	0.0000	0.0000	0.0000	0.0000	0.0000
38	5.8562	0.0000	3.0633	0.0000	0.0000	0.9407	1.8521	0.0000	0.0000	0.0000	0.0000
39	6.3609	0.0000	2.6227	0.0000	0.0000	1.2702	2.4680	0.0000	0.0000	0.0000	0.0000
40	6.4329	0.0000	1.9763	0.0000	0.0000	1.5483	2.9083	0.0000	0.0000	0.0000	0.0000
41	4.3616	0.0000	0.0000	0.0000	0.0000	1.5601	2.8015	0.0000	0.0000	0.0000	0.0000

47.

48.

49. C800 Cycle Tool (D. Santos)

Based on the work of Demetrio Santos.

C800 (D. Santos)[Uniforme]

Orbe en grados 1

Punto Prog. 1 1.7

25/04/ 2026

Fecha
+ 1 - 1
Semana
+ 1 - 1
Mes
+ 1 - 1
Año
+ 1 - 1
Otra
Hora Natal
Segundo
+ 1 - 1
Minuto
+ 1 - 1
26/06/1933
GMT 01:00:00
Otra

